

EDITION 2024

jardinico®

jardinico[®]



MADE FOR **SHADE**
& **OUTDOOR LIVING**



Our latest collections are thoughtfully curated to promote togetherness and offer the ultimate form of relaxation. Join us on a journey embracing the art of living and celebrating shared happiness.

Let the new season become a canvas for unforgettable experiences and may our collections become an integral part of the cozy gatherings and the pursuit of ultimate relaxation.

Our strength lies in the diversity of our collections, providing everything from top-notch umbrellas to dining tables, sunloungers and desired accessories. With a comprehensive view of your outdoor space, we offer unlimited possibilities, catering to every style through a wide range of models, colours and finishes. We believe that the essence of life is found in celebrating shared joy in all its facets.

Welcome to a season of connection, comfort and the pure enjoyment of life with Jardinico.

CARACTÈRE

JCP.1 SERIES	Ambience	10
	Technical	152
JCP.2 SERIES	Ambience	14
	Technical	153
JCP.3 SERIES	Ambience	18
	Technical	156
JCP.4 SERIES	Ambience	22
	Technical	159
JCP.5 SERIES	Ambience	26
	Technical	164
JCP.6 SERIES	Ambience	28
	Technical	165

ATTITUDE

AZORE	Ambience	34
	Technical	166
ANTEGO	Ambience	36
	Technical	167
LIMA	Ambience	40
	Technical	168
TULI <small>NEW</small>	Ambience	42
	Technical	169
AMALFI	Ambience	44
	Technical	170
MALIBU	Ambience	46
	Technical	171
CUBA	Ambience	50
	Technical	172
MOOREA	Ambience	52
	Technical	173

FURNITURE

TONDO NEW	Ambience	56
	Technical	176
COMO NEW	Ambience	64
	Technical	180
NOA UPDATED	Ambience	68
	Technical	182
NERO UPDATED	Ambience	76
	Technical	188
SCOOP	Ambience	80
	Technical	191
TUGU UPDATED	Ambience	84
	Technical	193
LEGNA UPDATED	Ambience	88
	Technical	197
NATURE UPDATED	Ambience	92
	Technical	201
TECCA	Ambience	96
	Technical	204
MAUROO UPDATED	Ambience	100
	Technical	207
FLEXX	Ambience	108
	Technical	212
KUDOS	Ambience	112
	Technical	218
MANTRA	Ambience	116
	Technical	219
BYBLOS	Ambience	120
	Technical	221
BOLSA UPDATED	Ambience	122
	Technical	222
MANI UPDATED	Ambience	124
	Technical	223
DINING CHAIRS	Ambience	126
	Technical	224
NESTING TABLES	Ambience	128
	Technical	226

DECORATION

POTTERY UPDATED	Ambience	132
	Technical	230
RUGS	Ambience	136
	Technical	234
POUFS	Ambience	138
	Technical	235
LIGHTING	Ambience	140
	Technical	236
ACCESSORIES	Ambience	144
	Technical	237
DECO CUSHIONS	Ambience	146
	Technical	238

OVERVIEWS

PROJECTS	References	148
CATEGORIES	Dining chairs	240
	Benches	241
	Bar & counter	241
	Dining tables	242
	Bistro tables	242
	Lounge chairs	243
	Sofas	244
	Sunloungers	245
	Daybeds	246
Low tables	246	
CARE & MATERIALS	Maintenance	248
	Accessories	250
	Materials	251

OUTDOOR SHADE CARACTÈRE COLLECTION

An intuitive view on shade solutions paying tribute to craftsmanship and technical insight was translated into the Caractère collection. A premium outdoor umbrella allowing unlimited shade possibilities and discreet luxury to your garden or terrace. Quality, aesthetics and durability merge together in a modern, chic and demanding world on exterior living.

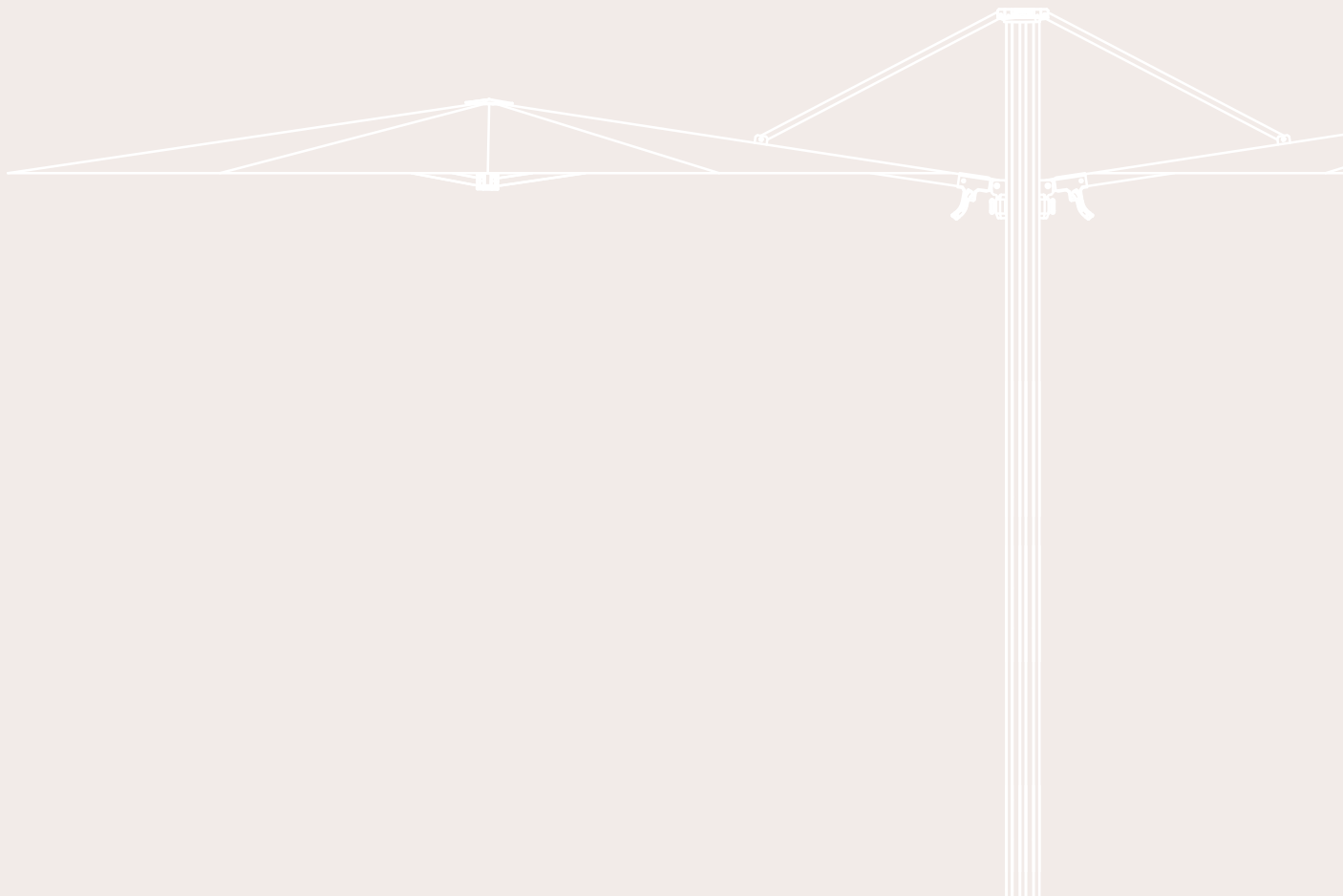



JCP 102 280 x 230 cappuccino & cotton - TONDO lounge chair 1S - NOA sofa side table



JCP. 102 230 x 230 cm cappuccino & cotton

JCP.1 SERIES

A perfect match for any project around the world, outdoor umbrellas that blend in seamlessly with the environment. Caractère One Series surprises thanks to its sturdiness.

With a canopy incline of 10°, the umbrella looks enormously flat, drawing attention to its sleek lines with an elegant touch.



JCP. 102 230 x 230 cm alu teak & ice - NERO sunloungers



JCP: 102 230 x 230 cm black & pitch



JCP: 102 230 x 230 cm alu teak & ice





JCP. 201 400 x 400 cm silver anodised & mooncrest - MAURO lounge - NESTING TABLE - WILSON rug

JCP.2 SERIES

Two series offers outdoor umbrellas that play a central role on your patio. A true eye-catcher, providing up to 25m² of shade. Thanks to a telescopic system, you can smoothly open and close the sturdy umbrella at arm height without touching other furniture. Despite their enormous strength, the umbrellas are very mobile due to its base.





JCP.203 ø 450 cm white & pearl - BAY poufs



JCP.202 500 x 500 cm white & pearl - FLEXX bistro



JCP.302 260 x 260 cm charcoal & onyx



JCP301 300 x 300 cm black & pitch

JCP.3 SERIES

The most iconic series from Caractère. Three Series includes umbrellas that are the heart of your garden, perfect for shelter and protection from the bright sun rays. Every model is extremely convenient to move and operate. By means of the slider, you can easily move this umbrella into every desired position and turn 360° without having to move its base.



JCP.301 300 x 300 cm charcoal & ice





JCP.301 300 x 300 cm white & umber - NOA lounge - MANTRA director chair - BAY pouf - WILSON rug



JCP.303 ø 350 cm charcoal & cotton - TUGU lounge



JCP.4 SERIES

Four series is home to a variety of environments all over the world. You may find them in both private use and large projects such as hotels, public buildings, resorts and pool areas.

An exceptionally sturdy outdoor umbrella with an elegant and luxurious appearance. Supported by a 245 kg - 540 lbs base and its dimensions, this series is the perfect marriage between Belgian design, enormous strength and guaranteed quality.



JCP.401 370 x 370 cm alu teak & cotton

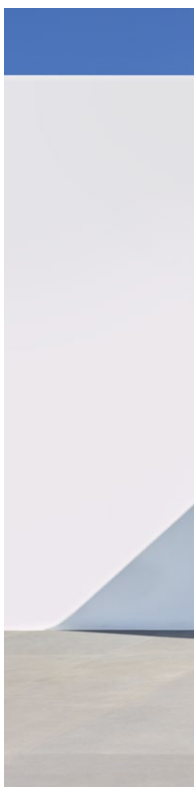



JCP. 403 ø 400 cm charcoal & umber



JCP. 404 250 x 350 cm charcoal & onyx - TECCA dining with YUNA dining armchairs



JCP. 501 4 * 300 x 300 cm alu teak & pearl - FLEXX bistro



JCP. 501 4 * 300 x 300 alu teak & pearl

JCP.5 SERIES

Five series has proven to be the ideal model for hospitality. With four separate outdoor umbrellas of 300 x 300 cm on one central pole, this model offers no less than 40m² of shade. Each umbrella can be tilted in height and opened individually.

Gutters are available to connect them to each other and enable large areas to have complete, uninterrupted coverage from the sun or rainy weather conditions.



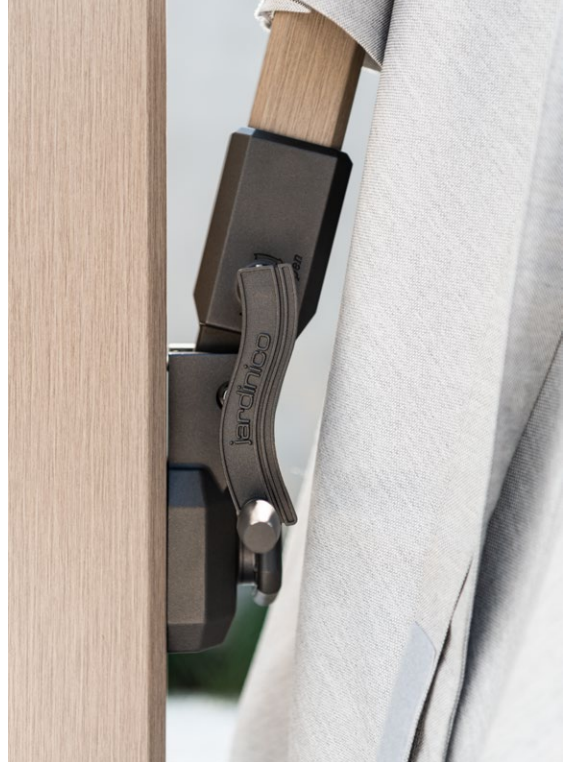

JCP.6 SERIES

An umbrella that will grace every large outdoor area by its Belgian design. The JCP.601 combines two outdoor umbrellas of 300 x 300 cm that can be opened, closed and tilted in height individually. Together they provide 18m² of shade. Thanks to one pole, the space underneath can be used optimally which makes this sunshade ideal for catering projects.



JCP.601 2 * 300 x 300 cm cappuccino & ice - TUGU lounge



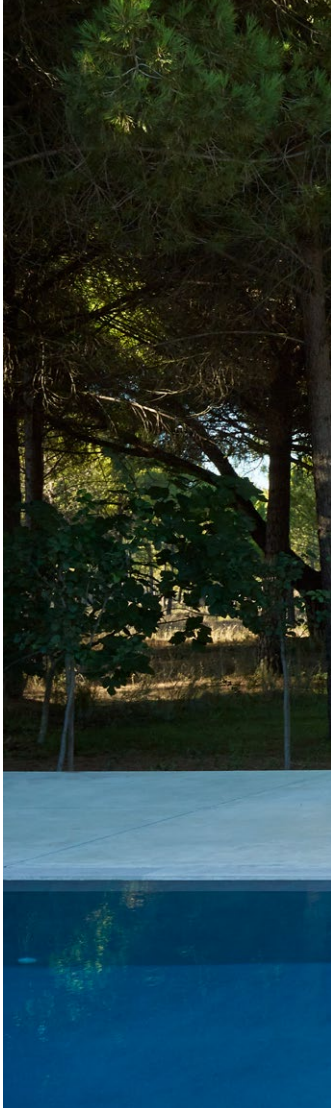

JCP. 601 2 * 300 x 300 cm charcoal & pearl - MAUROO lounge



OUTDOOR SHADE ATTITUDE COLLECTION

The Attitude collection includes outdoor umbrellas to suit everyone's preferences. A mid or free pole umbrella, wood or aluminium and a range of available colours for your canopy.

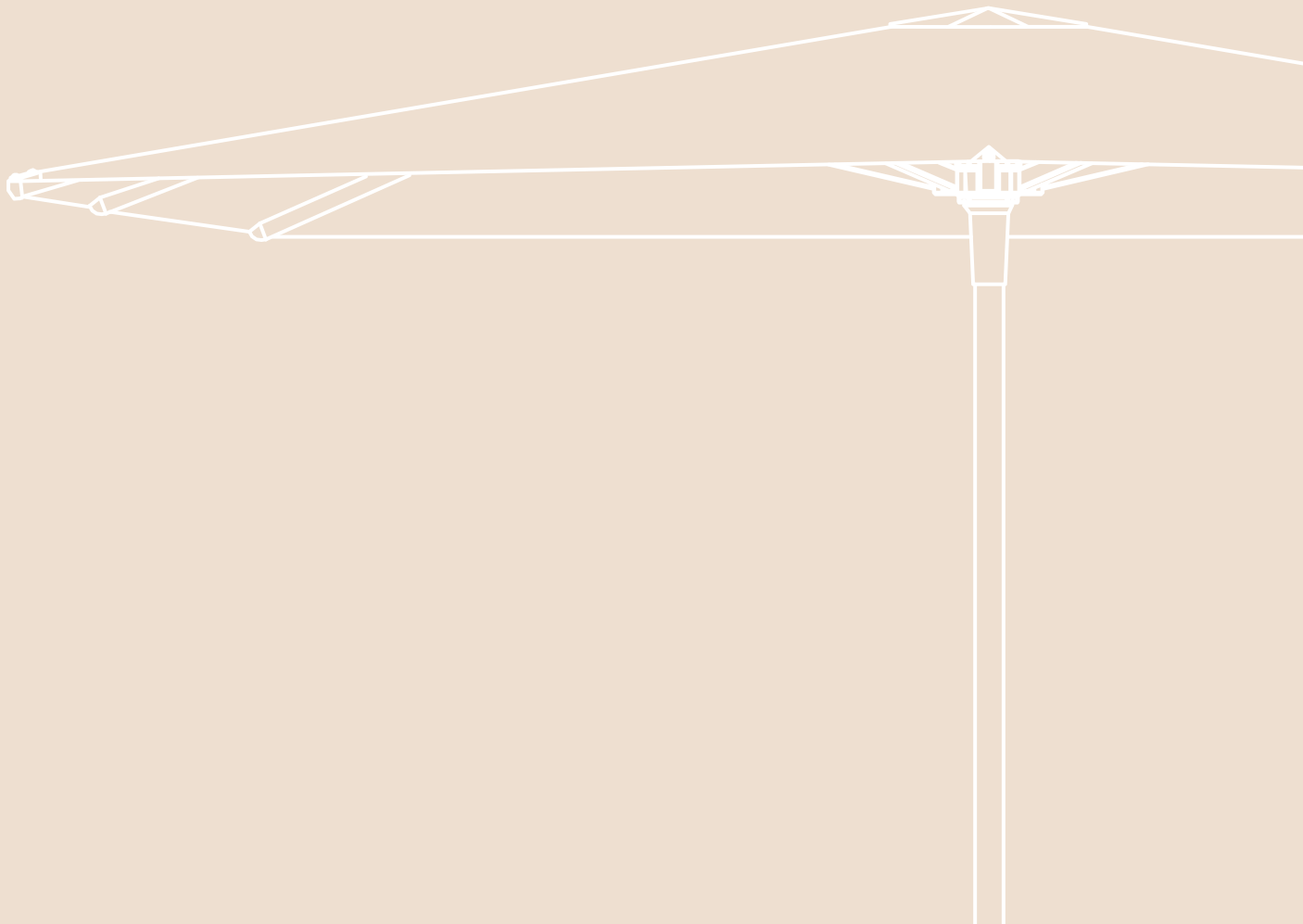



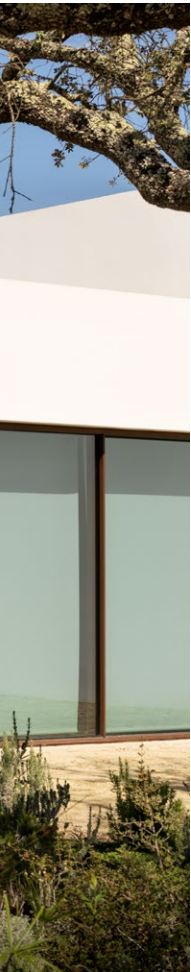

AZORE 300 x 300 cm black & black - NATURE dining with LEWIS armchairs



AZORE 300 x 300 cm anthracite & night

AZORE

Azore is a free pole umbrella that provides protection on all sunny days. Tilt the umbrella in height with a self-locking tooth belt system at the back of its pole or tilt left and right by means of the crank handle.

The pedal at the bottom of the pole allows you to rotate the umbrella 360° around its axis. Choose a colour combination to your preference and enjoy its sufficient shade on all sunny days, wherever you want on your terrace.



ANTEGO 300 x 200 cm linen & latte with linen concrete base

ANTEGO

Antego offers everything you expect from an outdoor umbrella and does not disappoint. Its operating system allows you to easily move and tilt your umbrella in any desired direction. By means of the pedal at the bottom of the pole, you can rotate the umbrella 360° around its axis.

This outdoor umbrella is developed to complement any outdoor area and give the protection you need all summer long.



ANTEGO 300 x 300 cm black & steel with silk grey granite base



ANTEGO ø 350 cm linen & cloud with sandstone base - TONDO lounge - TARO coffee tables - CUMINO conico pots - BAY pouf - WILSON rug



LIMA 400 x 400 cm black & night - BAY poufs





LIMA 400 x 300 cm linen & latte



LIMA

Lima, a sturdy umbrella with an elegant look, enhances the range of Attitude umbrellas. You can easily open and close the umbrella by means of the crank handle. By using the rotation pin, you can turn the umbrella 360° around its axis.



TULI 240 x 240 cm anthracite & gasoline - NERO relax - NOTO lighting



TULI 240 x 240 cm anthracite & gasoline, alu teak & natural & linen & latte



TULI

Introducing the Tuli umbrella, featherlight yet strong and steady.

With its compact dimensions of 240 x 240 cm, the Tuli is tailor-made for small terraces and various projects. Weighing 5.5 kg, this umbrella defies its lightweight nature, standing robust and steadfast, thanks to its dual locking pins. The innovative locking mechanism ensures a resolute and secure setup, providing stability even in gusty winds.

Enhancing its durability, the Tuli umbrella features flexible fiberglass rib ends. These resilient ribs not only contribute to the umbrella's overall strength but also ensure a lasting and reliable shelter for your outdoor spaces.





AMALFI 250 x 250 cm black & night - TUGU lounge



AMALFI 250 x 250 cm black & night

AMALFI

The perfect intermediate, fitting both smaller and larger areas. A design that spreads a luxurious appearance and gives the ultimate feeling of comfort, thanks to its push-up system.

Amalfi shows very slim, elegant lines and fits seamlessly into the design of modern urban landscapes, leisure resorts and private homes.

AMALFI ø 300 cm anthracite & night, 300 x 300 cm anthracite & gris nature, 250 x 250 cm alu teak & natural with LUCCA heavy bases anthracite





MALIBU 200 x 200 cm white & white - BAY poufs - TERRA pots



MALIBU ø 300 cm black & coal with LUCCA light base anthracite

MALIBU

A light and practical umbrella, ideal for every smaller terrace or along the swimming pool. You can determine the shade by tilting the umbrella, depending on the position of the sun. Malibu is here for everyone as we offer nine different colour combinations, next to six available sizes in a round, square and a rectangular shape. The umbrella is adjustable in height and has a powder coated aluminium frame with a water-repellent canopy.





MALIBU 250 x 200 cm white & light grey, 240 x 240 cm alu teak & white, 210 x 150 cm anthracite & dark grey, ø 250 cm anthracite & light grey



CUBA ø 350 cm eucalyptus & taupe

CUBA

Cuba is a timeless classic in the Attitude collection. It shows wood craftsmanship thanks to its frame made of eucalyptus wood with stainless steel, corrosion proof parts.

This umbrella shows its beauty around the globe and is developed to withstand tough, windy conditions in tropical climates.



CUBA 300 x 300 cm eucalyptus & natural - MAUROO lounge - NOTO lighting - KOBE side tables



MOOREA 300 x 300 cm teak scratched & natural - NOA sunloungers - DUNCAN teak blocks



MOOREA

An umbrella that is constructed to perform faultlessly and will grace your garden by its sleek and elegant touch. Moorea is finished by a scratched teak frame for a natural and rough finish, including a cord pulley to smoothly open and close the umbrella.

You are able to enjoy the perfect shade for many years to come because of a high performance and protective canopy. Moorea features a heavy duty frame with a diameter of 61 mm and is available with multiple base options.



MOOREA 300 x 300 cm teak scratched & taupe - TECCA sunloungers



OUTDOOR LIVING FURNITURE COLLECTION

Our aim is to create a place to unwind, where you feel the sun and can relax. There are unlimited possibilities, a collection for every style through a wide range of models, colours and finishes.

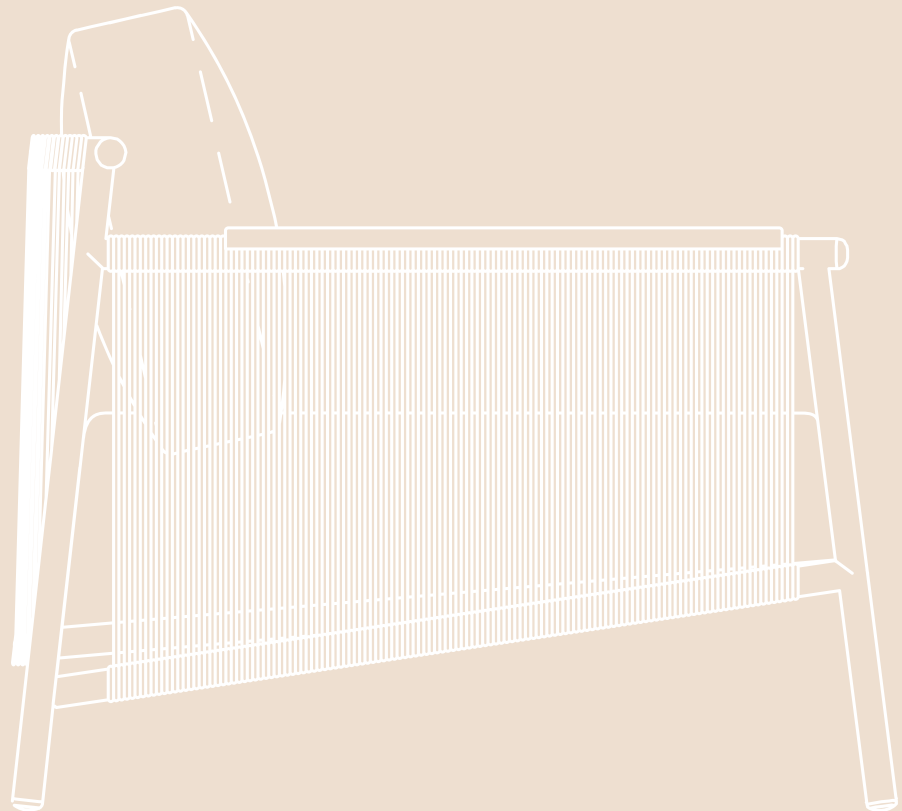



TONDO

Step into a world of mesmerising design with the Tondo collection, where each piece weaves a story of comfort and versatility.

The hallmark of this collection lies in the craftsmanship of a thick, multi-coloured 30mm rope. It is carefully intertwined into a visually captivating pattern that defines the essence of the entire collection.

This striking rope motif is complemented by the sturdy yet sleek powder-coated aluminium frame in a serene linen shade, which adds a touch of contemporary allure to the whole assembly.



TONDO modular organic island, 2.55 pampas & coffee table teak - BAY pouf large peacock
WILSON rug 280 x 390 cm oyster - DECO cushions papaya, wave, peacock & matcha





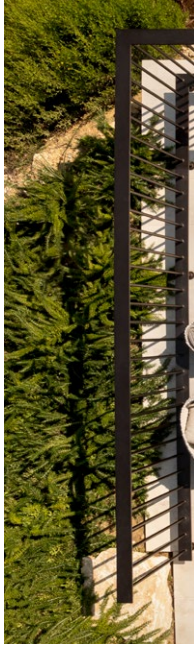

TONDO modular island, 2.5S, 3S, daybed pampas & coffee table teak - COMO nesting side tables
COCO rug 400 x 600 cm - TERRA dôme set macchiato





TONDO daybed pampas - NOA sofa side table - PRANA baskets
ANA deco cushion sakura & cobalt





TONDO sofa 3S pampas & side table teak - COMO nesting side tables - DECO cushions petrol & peacock



PRANA basket - DECO cushions papaya & amaretto



TONDO sofa 3S pampas - DECO cushions papaya & turtle





COMO organic dining table ø 160 cm - DUNE dining armchairs - CUMINO conico pots panna - COCO rug ø 300 cm

COMO

Designed with a keen eye for fluidity, this collection showcases graceful lines and embraces the beauty of organic, rounded forms.

Crafted from a unique blend of lime and concrete, each item is meticulously hand-applied with a spatula, resulting in a distinctive texture that marries the ruggedness of concrete with the smoothness of silk.

The material not only exudes a luxurious and silky texture but also boasts exceptional water repellency and waterproof properties, ensuring durability against all weather conditions.



JCP. 302 charcoal & onyx - COMO organic dining table 260 x 120 cm
NERO dining armchairs - WILSON rug 280 x 390 cm greige - ANTICO pots bronzo





TONDO lounge chair 1S pampas - COMO nesting side tables



NOA lounge chair 1S, ottoman brulé, sofa side table, divider - CUMINO conico pots ruggine



NOA

Noa collection, designed by Enrique Marti, establishes an oasis of tranquillity. Creating a calming, serene environment is the aim of this collection and inspired us also on the name of this collection. Noa - Noach which means rest and peace.

Characterised by its curving, the framework is made of natural teak that pays homage to old craftsmanship. The feeling of being close to nature continues thanks to the hand woven strap with a subtle touch of green.



NOA lounge chair 1S truffle, side table - DECO cushions cotta & sage



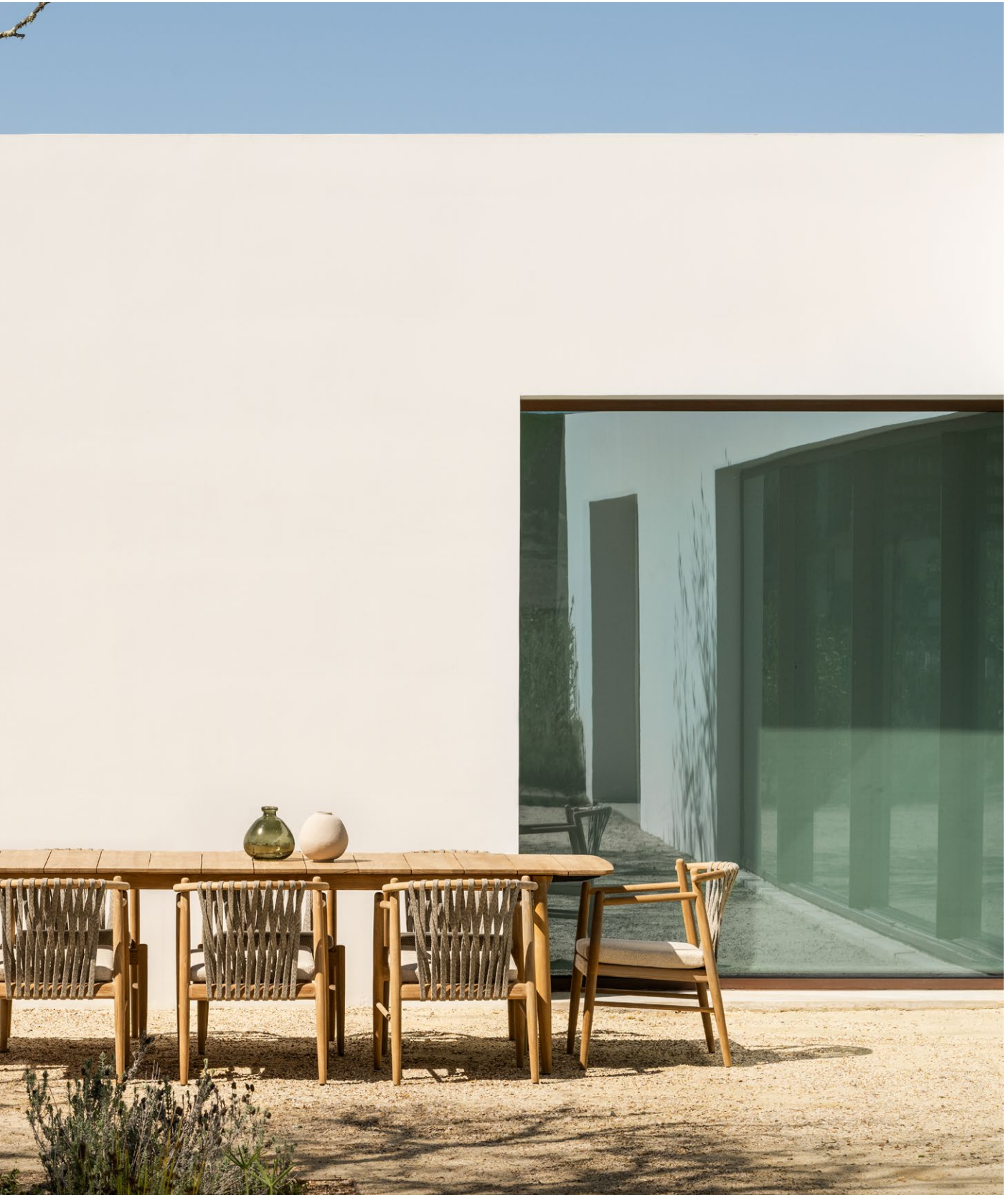

NOA dining table 270 x 120 cm, dining chairs & armchairs - CUMINO fiore set ruggine



NOA dining table 270 x 120 cm, dining chairs & armchairs





NOA lounge chair 1S, 3S, ottoman brûlé & coffee table, sofa side table - DECO cushions cotta & scarlett



NOA sunlounger truffle & side table



NOA chaise longues, sofa side table - COMO nesting side tables - TULLI umbrella linen & latte





NERO

Nero, a black-teak framed collection that adapts to every kind of exterior, has its focus on comfort and durability. We embraced the challenge of mixing the toughness of black coated teak with the elegance of sand coloured hand woven rope.

Dining armchairs with a curved back ensure a maximum of comfort while dining with your beloved ones.



NERO dining table 300 x 100 cm, dining armchairs brûlé - WILSON rug 250 x 350 cm oyster



LIMA umbrella 400 x 400 cm black & black - NERO sofa 1S, 2S, 3S truffle & coffee table - DECO cushions corn, wave & sage
CUMINO fiore pots ruggine - NERO dining



TULLI umbrella 240 x 240 cm anthracite & night - NERO sunlounger & side table - NOTO oval





SCOOP sunloungers white & beige - DUNCAN teak block - MALIBU 200 x 200 cm white & light grey

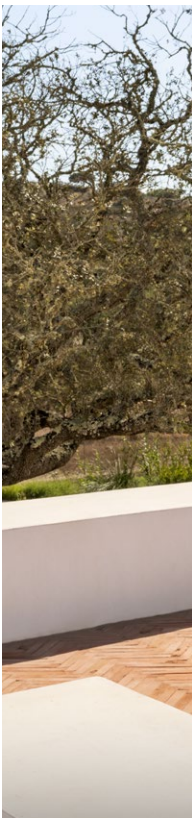

SCOOP

Natural and relaxed features, incorporated into sublime quality materials with a sophisticated appearance. Scoop collection provides elegant grace and develops a neutral touch to emerge with the environment. Its colour and craftsmanship are made for an exceptional view on your garden.

Each lounge chair and sofa is surrounded by hand woven rope with a thickness of 4 mm. The aluminium frame, which exists in white and lava, merges beautifully together with the rope and solid wooden armrests.



SCOOP sofa 1S, 2S, 3S white & beige - DUNCAN teak blocks - NESTING table ø 40 cm white & teak - DECO cushions wave





JCP.301 300 x 300 cm charcoal & cotton - SCOOP sofa 1S, 2S, 3S lava & beige - DUNCAN teak blocks - BAY poufs - DECO cushions corn & vanilla
WILSON rug 280 x 390 cm oyster





JCP.601 2* 300 x 300 cm cappuccino & ice - TUGU 1S, 2S, 3S linen - coffee table ø 90 cm & ø 120 cm, side table ø 45 cm sable teak

TUGU

Tugu collection unveils a new classic that seamlessly connects its design to the surroundings. Unique outdoor furniture pieces with soft contours setting out a balance between a modern and contemporary design with a classic, yet inviting look.

True craftsmanship is brought to life through hand woven wicker portraying an elegant landscape and focusing attention on all details.



TUGU sunloungers & side table ø 45 cm sable teak



TUGU daybed, pottery set & side table ø 45 cm taupegrey - JCP.102 cappuccino & cotton - COCO rug ø 300 cm





TUGU coffee table ø 90 cm taupegrey & side table ø 45 cm teak



JCP.303 ø 350 cm charcoal & cotton - TUGU sofa 1S, 2S, 3S linen, coffee table ø 90 cm & ø 120 cm, side table ø 45 cm sable teak



LEGNA dining table 240 x 100 cm taupegrey & dining armchairs cream - WILSON rug 280 x 390 cm oyster



LEGNA chaise longues & side table - DECO cushion corn



LEGNA

We pay tribute to true craftsmanship that merges perfectly with nature's colours and materials. The ceramic table top is characterized by its intense taupe and grey colours with a subtle pattern and pores. Each piece stands on its own and is not replicable.

The entire collection fits both rustic as well as modern environments and offers maximum comfort.



LEGNA lounge chair 1S & side table - DECO cushion corn



LEGNA sofa 1S, 2.5S & coffee table - CURVO pot caffè



NATURE low dining table 280 x 120 cm - LEWIS low dining armchairs vanilla



NATURE

The beauty of raw, solid teak makes every piece unique with an irregular touch. All dining tables and benches are carried by a sturdy powder coated aluminium frame for extra support.

The collection includes a normal dining table, but also a low dining concept. These are slightly lower than a traditional dining setting and create a relaxed posture allowing you to enjoy hours of dining that overflows in an endless evening full of joy.



NATURE low dining table 280 x 120 cm - LEWIS low dining armchairs vanilla





NATURE dining table 280 x 120 cm & bench 280 cm - MANTRA director chairs anthracite





TECCA

Tecca collection creates an open space that breathes warmth by the materials that are selected to be enduring and set the tone. Constructed from aged teak, a unity of materials ensuring a visual serenity. The natural earth colour softens the ambience and takes on a sober, yet sophisticated look and feel.

Its solid teak frame, which becomes even more beautiful over time, is supported by an invisible aluminium frame for maximum strength. The dining tables can be matched with chairs from several collections like Yuna, Lewis and Kudos.



TECCA dining table 320 x 100 cm - YUNA dining armchairs charcoal & ebony



TECCA dining table 320 x 100 cm, bench 130 cm - YUNA dining armchairs charcoal & ebony



TECCA dining table 160 x 80 cm - YUNA dining armchairs linen & beige

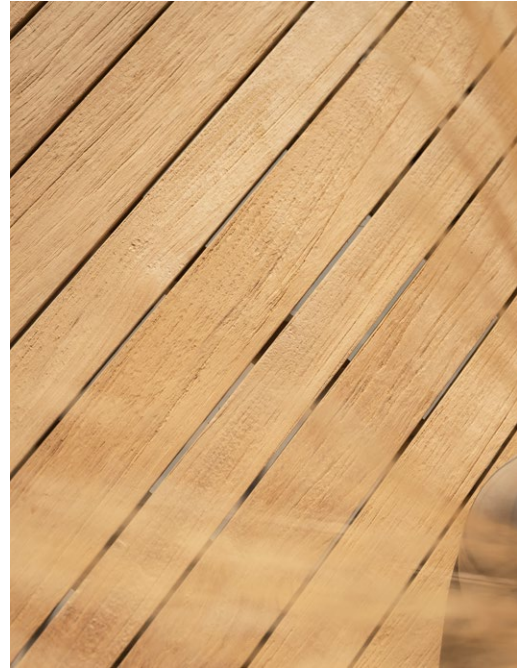



TECCA sunloungers beige - MOOREA teak scratched & taupe





JCP201 silver & mooncrest - MAUROO long sofa with teak table, 2x sofa, 2S, modular table & coffee table taupegray
NESTING table ø60 cm charcoal & teak - WILSON rug 280 x 390 cm greige - BAY pour medium papaya
DECO cushion papaya, amaretto & ray

MAUROO

Mauroo comes with unlimited possibilities, adapted to your choice and preference. Its modular design and versatile use are translated into a unique concept that fits every patio. Choose between two colors for the frame and cushions, and explore a variety of options for the table top.

Developed to exceed all expectations, the collection comprises high-performance outdoor cushions with large volume and is supported by an elegant aluminium frame.





MAURÍO sofa 2S long sofa with table & modular table bianco - NESTING table ø 90 cm white & bianco
COCO poufs 50 x 40 cm & 100 x 40 cm - DECO cushions wave, petrol & mint - COCO rug 300 x 400 cm - WILSON rug 200 x 300 cm greige





MAUROO chaise longue white & vanilla with bianco & teak table top - CUBA 300 x 300 cm eucalyptus & natural NOTO comic lighting - KOBE side tables









FLEXX sofa 1S, 2S, 3S marble & coffee table

FLEXX

Flexx leaves a lasting impression through its timeless class and quality teak. A collection in which teak plays the leading role by an alternation of clean, elegant and curved lines. All pieces in this collection are suitable for both indoor and outdoor use.

They portray the inviting look of natural teak and signature design of Flexx. A perfect setting to have relaxing moments with family or guests and enjoy your day to the fullest.



FLEXX bar and counter table with accompanying chairs marble - ANTIBES winetub



FLEXX daybed marble





FLEXX dining table 240 x 100 cm, dining armchairs marble

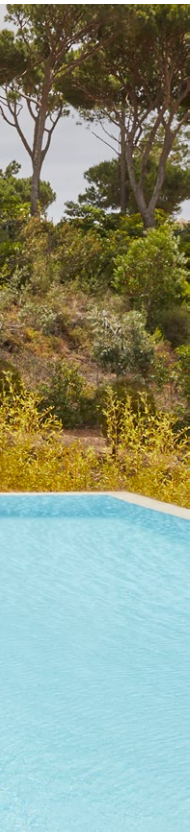

FLEXX sunloungers marble





KUDOS bistro table & armchairs black



KUDOS bistro armchair white

KUDOS

Punctuated by its versatile use and converted from a practical insight, Kudos collection suits a variety of terrace schemes. Constructed from powder coated aluminium, Kudos chair and bistro tables feature a clean and stylish design to offer a sleek and contemporary outdoor solution.

The frivolous and light chair is available in a playful lime colour, elegant linen or timeless black or white. The eclectic mix of colours makes Kudos mesmerising in every bistro setting.



KUDOS bistro armchair lime & white



KUDOS bistro armchair linen



KUDOS bistro table square white, armchairs white, black & linen





MANTRA director chairs anthracite

MANTRA

Bistro combines minimalism and bespoke solutions to create the best terrace concept. This collection suits perfectly for any small terrace or hospitality project. Combine a heavy aluminium base and table top with hand woven dining armchairs or foldable director chairs.



MANTRA bistro table, director chairs anthracite



MANTRA sunloungers white & silver



MANTRA bistro table & armchairs anthracite



MANTRA bistro table & armchairs white



BYBLOS beach chair anthracite



BYBLOS beach chair anthracite & beach stand

BYBLOS

Slide into your private getaway with the Byblos beach chair and enjoy every sunshine of the day. With four possible positions and a double upholstered seat, we ensure you hours of maximum comfort.

If you would like to store multiple Byblos chairs conveniently, we offer a separate stand which enables you to fit your beach chairs nicely together.

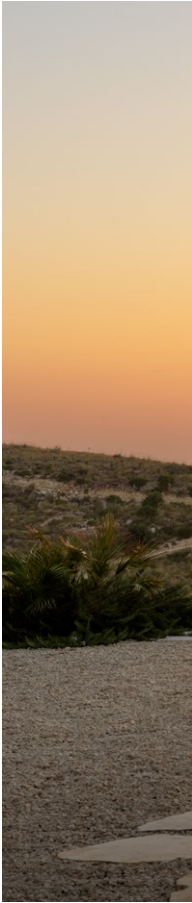

BOLSA 170 cm matcha - PRANA basket small & large



JCP102 230 x 230 cm cappuccino & umber - BOLSA 150 cm lime, 125 cm azul, 170 cm matcha
TONDO side table teak

BOLSA

Playfulness, comfort and cosiness are the ingredients of Bolsa. Whether you use it to unwind by the pool or as an eye-catcher for your outdoor space, this beanbag is always a good idea.

Choose the short model or settle for the long versions for a chilly afternoon by the pool.



MANI footstool & BAY pouf small matcha



MANI dining armchair brulé



MANI dining armchair brulé - COMO dining table ø 160 cm - ARCQ lighting



MANI lounge chair & footstool - BAY pouf small matcha - DECO cushion petrol & matcha

MANI

Crafted to elevate your dining and lounging experiences, this collection comprises a dining chair, lounge chair and complementary footstool.

This meticulous weaving not only adds a touch of artisanal charm but also provides a comfortable and supportive seating experience. The almond-coloured rope is elegantly framed by a powder-coated aluminum structure in a matching shade.



LEWIS low dining armchair - NATURE low dining table 280 x 120 cm



DINING CHAIRS

Experience unparalleled comfort and exquisite style with our exclusive collection of dining chairs.

Our curated selection includes a variety of materials such as teak and rope, each designed with the same goal in mind - to ensure you enjoy a maximum level of comfort, allowing you to indulge in endless moments around the dining table.



TECCA dining table 160 x 80 cm - YUNA dining armchairs linen & beige



COMO dining table ø 160 cm - DUNE dining armchairs - COCO rug ø 300 cm



KOBE side tables small & large



DUNCAN teak blocks



TARO coffee table round & organic - TONDO 1S, 3S, daybed - DECO cushions ray & amaretto - WILSON rug

NESTING TABLES

Enhance the ambiance of your lounge area by incorporating a stylish set of accent tables, adding that perfect extra touch and creating a functional space.

Explore our nesting tables that offer a play of shapes in teak, as well as in aluminium and ceramic.



NESTING tables white & teak, lava & bianco, charcoaltable top

OUTDOOR LIVING DECORATION COLLECTION

No outdoor area is complete without a striking accessory. Whether it's a heavy-duty outdoor rug, some poufs that perfectly match your furniture cushions, or a set of decorative items to add that finishing touch, our range has you covered. Choose from various sizes, materials and fabrics that suit your style, allowing our selection of decoration items to enhance the envisioned look of your garden and terrace.



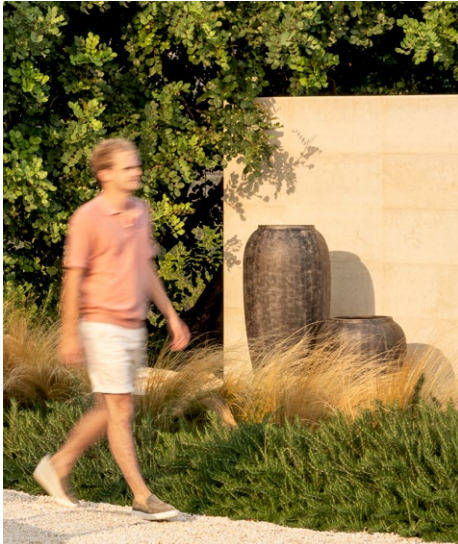

ANTICO anfora & vaso brozno



ANTICO anfora & vaso pistachio

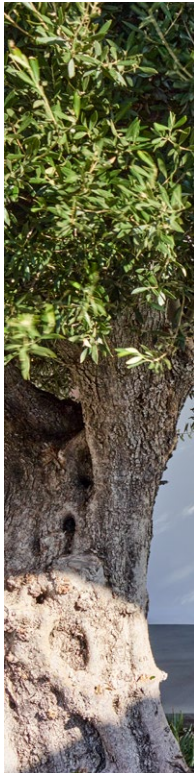

TERRA alto macchiato





CURVO set caffè



CARTELLO marone



TERRA balloon nero

POTTERY

Each planter is made with natural materials, combined with FRP. All designs and shapes offer the finishing touch to every patio. Enjoy yours for many years to come due to its weather and UV resistance.



CUMINO fungo panna



CUMINO fiore set ruggine





TERRA cerchio macchiato



CUMINO calice panna



TERRA classic macchiato



CUMINO conico panna



NOA lounge chair 15 brûlé, side table - YARA rug 300 x 400 cm



RUGS

A beautiful rug creates a warm environment, even outside in your garden. Go for a chunky one with thick rope or with long hairs for your lounge and a tighter rug for your dining area.

COCO rug - WILSON rug oyster



NOA sofa 2S - COCO rug ø 300 cm



TONDO lounge chair 1S pampas - KOBE side table small - IONA rug ø 300 cm



COCO pouf round small & large, square small



BAY poufs small, medium & large

POUFS

The collection offers a range of sizes from round to square and from small to large poufs. Choose a material, colour and finish to your preference and complete your setting.



NOTO oval small & large





ARCO small & large

LIGHTING

Nothing better than a warm outdoor light to make summer evenings more cozy. Our lanterns in teak or aluminium and solar-powered LED lights provide a pleasant atmosphere every single time.



NOTO conic small

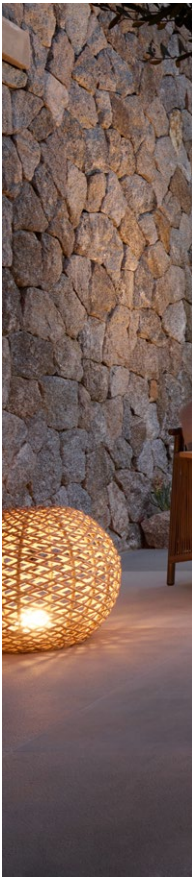



SOLORE cube set taupe



SOLORE sphere set natural - SCOOP lounge chairs lava & brown



ANTIBES winetub teak



ANTIBES winecooler teak

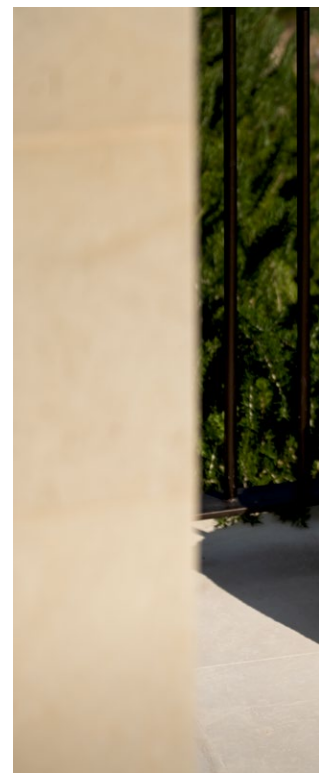

ACCESSORIES

Elevate your space with our exquisite range of accessories, designed to add the perfect finishing touch to any setting.



PRANA baskets small & large





DECO cushions papaya, peacock & wave





ANA deco cushions sakura, cobalt & thyme

DECO CUSHIONS

A few outdoor deco cushions create extra cosiness in your garden. Choose energising colours to create a pop of colour or go for earth tones for a more chic and relaxing vibe.



DECO cushion 50 x 30 cm papaya

PROJECT REFERENCES

Fairmont Royal palm - Marrakesh - Marrocco
Sea lounge - Porto-Vecchio - Corsica
Cove beach - Dubai - UAE
Limonade Maillot - Paris - France
Kempinski - Aqaba - Jordan
Jules Bar - Kortrijk - Belgium
Radisson Blu - Wiesbaden - Germany
Limonade Maillot - Paris - France
Wittamer - Brussels - Belgium
Kempinski Hotel - Bruges - Belgium
Blue Origin - Deerlijk - Belgium
Blue Buddha Beachclub - Knokke - Belgium
Collin's Beach - Knokke - Belgium
Bar d'O Beach Club - Knokke - Belgium
Blue Buddha beach club - Knokke - Belgium
Kruisheren Hotel - Maastricht - The Netherlands
Country Club - Samois Sur Seine - France
Koevert - Avelgem - Belgium
Le Couvent des Minimes - Mane - France
Hôtel Julien - Fouday - France
Peninsula - Paris - France
Golf Up - Grimaud - France
Nørgaard - Hornbaek - Denmark
La Plage - Casadelmar - Corsica
Yacht Club - Porto Montenegro
Botanic Sanctuary - Antwerp - Belgium
La Gazelle d'Or - Tunesia
Parkhotel - Kortrijk - Belgium
Domaine de coyieux - Beaumes-de-Venise - France
Royal Hideaway Corales - Tenerife - Spain
Eyebar - Hong Kong - China
Honi Honi Bar - Hong Kong - China
Wooloo Mooloo - Hong Kong - China
Retreat & Spa - Maledives
Berjaya Hotel - Kuala Lumpur - Malaysia
Mulia Hotel - Bali - Indonesia
Age-Hassim Hill - Singapore
Joe's Café - Doha - Qatar
Utopia - Abu Dhabi
Mercure Hotel Harbourside - Carens - Australia
Omma - Santorini - Greece
Royalton Hotel Riviera Cancun - Mexico
Ocean Club - Marbella - Spain
Grand Palladium Lady Hamilton - Jamaïca
Radisson Blu - Dakar - Senegal
Golf Club Saint-Tropez - Saint Tropez - France
La mère germaine - Châteauneuf-du-Pape - France
Villa Gemini - Mykonos - Greece
The Ritz-Carlton - Cyprus





TECHNICAL SPECIFICATIONS

The representation of colours, dimensions and weights may differ from reality as may variations when a product is handmade. Dimensions and technical details are subject to change without prior notice. Jardinico reserves the right to make any improvements such as technological and aesthetical modifications to its models, including adjustments of sizes and materials when it comes to technical developments or availability of raw materials.

JCP.1 SERIES

Center pole frame, powder coated aluminium.
Canopy 100% solution dyed acrylic, 320 gr/m².
Tilt and rotation not applicable.

base 44 kg: max. 43 km/h, 26.7 mph
base 65 kg: max. 58 km/h, 36 mph







JCP.102 - 230 X 230 CM

UFJCP.102 FRAME

	A01 white		A02 silver
	A03 linen		A10 cappuccino NEW
	A12 alu teak		A31 charcoal
	A32 black		





MIX & MATCH

UCJCP.102 CANOPY

	C003 pearl		C011 cotton
	C100 ice		C107 mooncrest
	C207 onyx		C210 pitch
	C305 umber		

Free pick: other fabrics on demand

UBJCP.1S BASE - PARASOLVOET 44 kg

	S01 white		S02 silver
	S03 linen		S31 charcoal
	S32 black		

UBJCP.1S65 base - parasolvoet 65 kg (same colours as base 44 kg)

UBIGB-JCP.1S in ground base / UBOGB-JCP.1S on ground base

COVER

	UPJCP.1S-X77 black
---	--------------------

17 kg, 37.5 lbs nett
excl. base

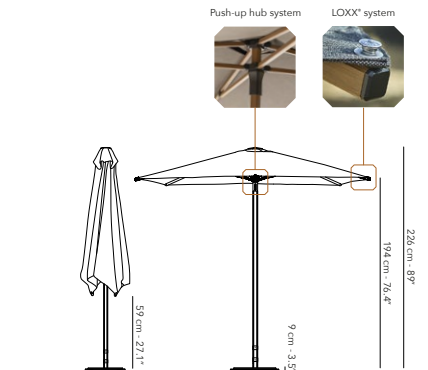

All dimensions exclude the base.
*Easy to open and close without touching furniture.

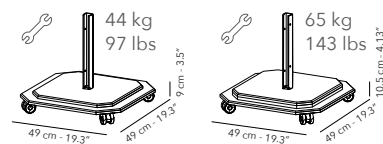
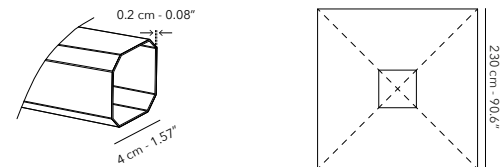

Hot galvanized steel plates, powder coated.
Four mounted wheels that rotate 360°, each with a brake.
Has the same colour as its frame.
An alu teak or cappuccino frame has a charcoal base.

Center pole frame, powder coated aluminium.
 Canopy 100% solution dyed acrylic, 320 gr/m².
 Tilt and rotation not applicable.



JCP.2 SERIES

max. 58 km/h, 36 mph

JCP.201 - 400 X 400 CM



56 kg, 123.5 lbs nett
 excl. base

UFJCP.201 FRAME

	A01 white		A02 silver
	A31 charcoal		

MIX & MATCH

UCJCP.201 CANOPY

	C003 pearl		C011 cotton
	C100 ice		C107 mooncrest
	C207 onyx		C210 pitch
	C305 umbra		

Free pick: other fabrics on demand

UBJCP.2S-3S BASE

	S01 white		S02 silver
	S31 charcoal		

UBIGB-JCP.2S-3S in ground base / UBOGB-JCP.2S-3S on ground base

OPT. OPTIONAL

UAJCP.2S-3S in/on ground base plate cover (same colours as base)

COVER

	UPJCP.2S-X77 black
---	--------------------

GUTTERS

UAJCP.2S colour of the canopy

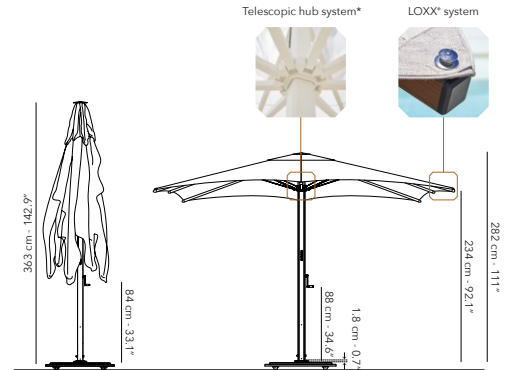

All dimensions exclude the base.
 *Easy to open and close without touching furniture.

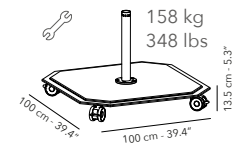
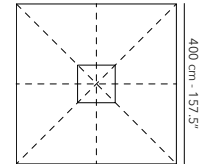
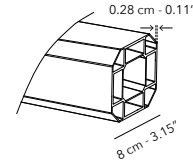

Hot galvanized steel plates, powder coated.
 Four mounted wheels that rotate 360°, each with a brake.
 Has the same colour as its frame.



JCP.2 SERIES

Center pole frame, powder coated aluminium.
Canopy 100% solution dyed acrylic, 320 gr/m².
Tilt and rotation not applicable.

JCP.202 - 500 X 500 CM





max. 58 km/h, 36 mph

UFJCP.202 FRAME

	A01 white		A02 silver
	A31 charcoal		

MIX & MATCH

UCJCP.202 CANOPY

	C003 pearl		C011 cotton
	C100 ice		C107 mooncrest
	C207 onyx		C210 pitch
	C305 umber		

Free pick: other fabrics on demand - autres tissus sur demande - andere stoffen op aanvraag

UBJCP.2S-3S BASE

	S01 white		S02 silver
	S31 charcoal		

UBIGB-JCP.2S-3S in ground base / UBOGB-JCP.2S-3S on ground base

OPT.

UAJCP.2S-3S in/on ground base plate cover (same colours as base)
OPTIONAL

COVER

	UPJCP.2S-X77 black
---	--------------------

GUTTERS

UAJCP.2S colour of the canopy

56 kg, 123.5 lbs nett
excl. base

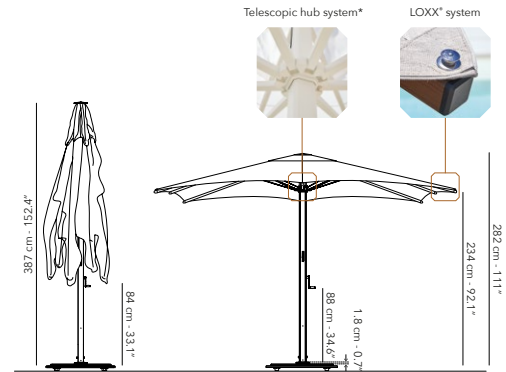

All dimensions exclude the base.
* Easy to open and close without touching furniture.

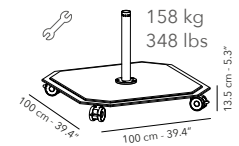
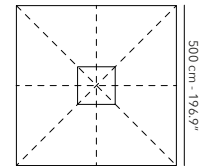
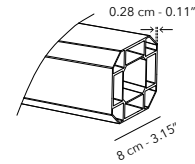

Hot galvanized steel plates, powder coated.
Four mounted wheels that rotate 360°, each with a brake.
Has the same colour as its frame.



Center pole frame, powder coated aluminium.
 Canopy 100% solution dyed acrylic, 320 gr/m².
 Tilt and rotation not applicable.

JCP.2 SERIES

JCP.203 - Ø 450 CM





max. 58 km/h, 36 mph

UFJCP.203 FRAME

	A01 white		A02 silver
	A31 charcoal		

MIX & MATCH

UCJCP.203 CANOPY

	C003 pearl		C011 cotton
	C100 ice		C107 mooncrest
	C207 onyx		C210 pitch
	C305 umber		

Free pick: other fabrics on demand

UBJCP.2S-3S BASE - PARASOLVOET

	S01 white		S02 silver
	S31 charcoal		

UBIGB-JCP.2S-3S in ground base / UBOGB-JCP.2S-3S on ground base

OPT.

UAJCP.2S-3S in/on ground base plate cover (same colours as base)
 OPTIONAL

COVER

	UPJCP.2S-X77 black
---	--------------------

42 kg, 92.6 lbs nett
 excl. base

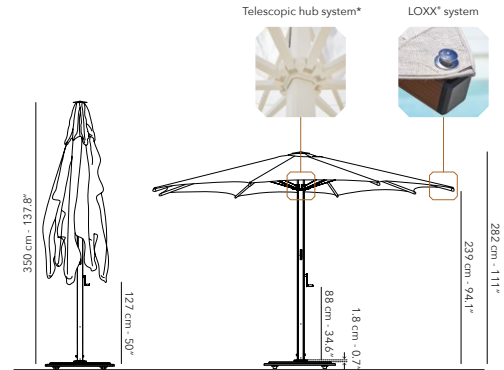

All dimensions exclude the base.
 * Easy to open and close without touching furniture.

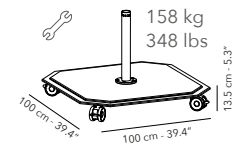
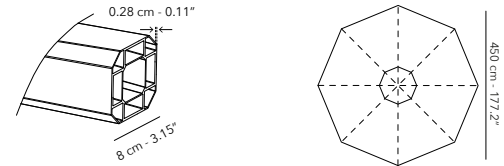

Hot galvanized steel plates, powder coated.
 Four mounted wheels that rotate 360°, each with a brake.
 Has the same colour as its frame.

JCP.3 SERIES

Free pole frame, powder coated aluminium.
Canopy 100% solution dyed acrylic, 320 gr/m².
Tilt in height, left and right, rotation 360°.

JCP.301 - 300 X 300 CM



max. 58 km/h, 36 mph

UFJCP.301 FRAME

	A01 white		A03 linen
	A10 cappuccino		A12 alu teak
	A31 charcoal		A32 black

MIX & MATCH

UCJCP.301 CANOPY

	C003 pearl		C011 cotton
	C100 ice		C107 mooncrest
	C207 onyx		C210 pitch
	C305 umber		

Free pick: other fabrics on demand

UBJCP.2S-3S BASE

	S01 white		S03 linen
	S31 charcoal		S32 black

UBIGB-JCP.2S-3S in ground base / UBOGB-JCP.2S-3S on ground base

OPT. UAJCP.2S-3S in/on ground base plate cover (same colours as base)
OPTIONAL

COVER

	UPJCP.3S-X77 black
--	--------------------

42 kg, 92.6 lbs nett
excl. base

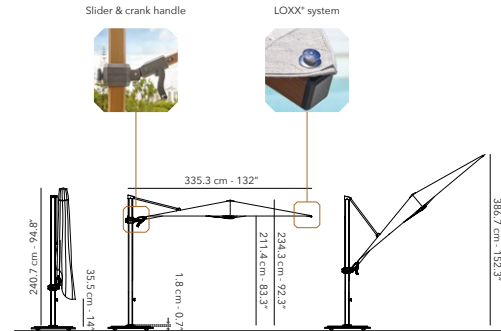

All dimensions exclude the base.

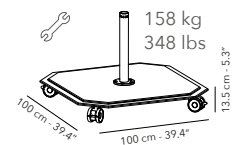
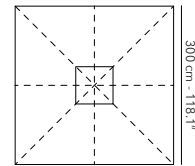
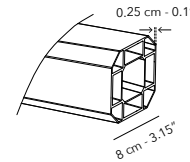

Hot galvanized steel plates, powder coated.
Four mounted wheels that rotate 360°, each with a brake.
Has the same colour as its frame.
An alu teak or cappuccino frame has a charcoal base.

Free pole frame, powder coated aluminium.
 Canopy 100% solution dyed acrylic, 320 gr/m².
 Tilt in height, left and right, rotation 360°.

JCP.3 SERIES

JCP.302 - 260 X 260 CM



max. 58 km/h, 36 mph

UFJCP.302 FRAME

	A01 white		A02 silver
	A10 cappuccino		A12 alu teak
	A31 charcoal		

MIX & MATCH

UCJCP.302 CANOPY

	C003 pearl		C011 cotton
	C100 ice		C107 mooncrest
	C207 onyx		C210 pitch
	C305 umber		

Free pick: other fabrics on demand

UBJCP.2S-3S BASE

	S01 white		S02 silver
	S31 charcoal		

UBIGB-JCP.2S-3S in ground base / UBOGB-JCP.2S-3S on ground base

OPT. UAJCP.2S-3S in/on ground base plate cover (same colours as base)
 OPTIONAL

COVER

	UPJCP.3S-X77 black
--	--------------------

31 kg, 68.3 lbs nett
 excl. base

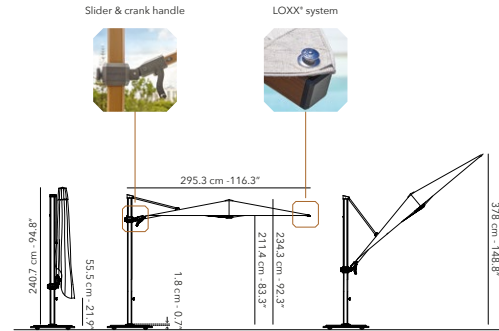

All dimensions exclude the base.

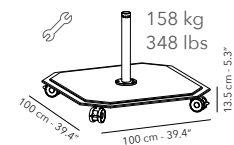
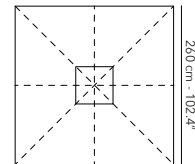
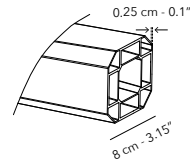

Hot galvanized steel plates, powder coated.
 Four mounted wheels that rotate 360°, each with a brake.
 Has the same colour as its frame.
 An alu teak or cappuccino frame has a charcoal base.

JCP.3 SERIES

Free pole frame, powder coated aluminium.
Canopy 100% solution dyed acrylic, 320 gr/m².
Tilt in height, left and right, rotation 360°.

JCP.303 - Ø 350 CM



max. 58 km/h, 36 mph

UFJCP.303 FRAME

MIX & MATCH		A01 white		A02 silver
		A10 cappuccino		A12 alu teak
		A31 charcoal		
	UCJCP.303 CANOPY			
		C003 pearl		C011 cotton
		C100 ice		C107 mooncrest
		C207 onyx		C210 pitch
		C305 umber		

Free pick: other fabrics on demand

UBJCP.2S-3S BASE

OPT.		S01 white		S02 silver
		S31 charcoal		
	UBIGB-JCP.2S-3S in ground base / UBOGB-JCP.2S-3S on ground base			
UAJCP.2S-3S in/on ground base plate cover (same colours as base)				
OPTIONAL				
COVER				
	UPJCP.3S-X77 black			

34 kg, 75 lbs nett
excl. base

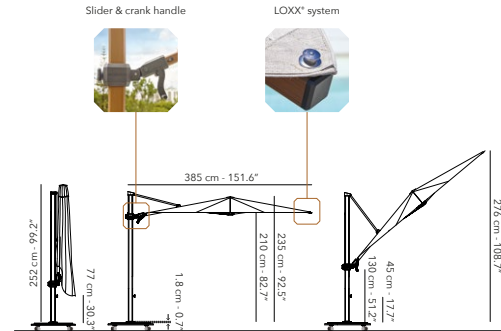

All dimensions exclude the base.

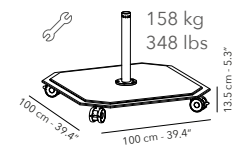
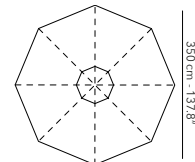
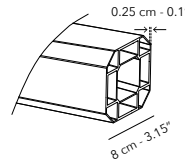

Hot galvanized steel plates, powder coated.
Four mounted wheels that rotate 360°, each with a brake.
Has the same colour as its frame.
An alu teak or cappuccino frame has a charcoal base.

Free pole frame, powder coated aluminium.
 Canopy 100% solution dyed acrylic, 320 gr/m².
 Tilt in height, left and right, rotation 360°.

JCP.4 SERIES

JCP.401 - 370 X 370 CM



max. 58 km/h, 36 mph

UFJCP.401 FRAME

	A01 white		A02 silver
	A03 linen		A10 cappuccino
	A12 alu teak		A31 charcoal
	A32 black		

MIX & MATCH

UCJCP.401 CANOPY

	C003 pearl		C011 cotton
	C100 ice		C107 mooncrest
	C207 onyx		C210 pitch
	C305 umber		

Free pick: other fabrics on demand

UBJCP.4S BASE

	S01 white		S03 linen
	S31 charcoal		S32 black

UBIGB-JCP.4S-5S-6S in ground base /
 UBOGB-JCP.4S-5S-6S on ground base

COVER

	UPJCP.4S-X77 black
--	--------------------

64 kg, 141.1 lbs nett
 excl. base

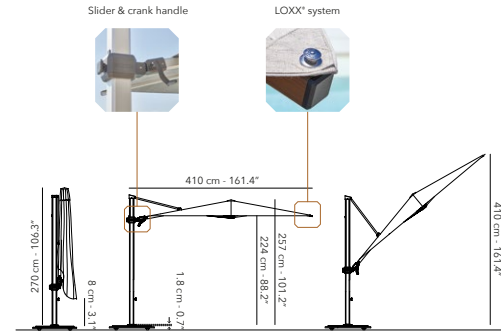

All dimensions exclude the base.

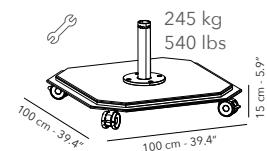
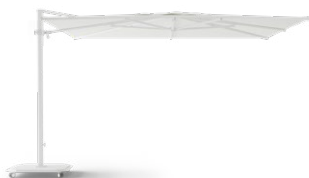
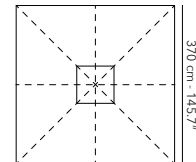
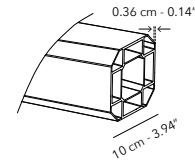

Hot galvanized steel plates, powder coated.
 Four mounted wheels that rotate 360°, each with a brake.
 Has the same colour as its frame.
 An alu teak or cappuccino frame has a charcoal base.

JCP.4 SERIES

Free pole frame, powder coated aluminium.
Canopy 100% solution dyed acrylic, 320 gr/m².
Tilt in height, left and right, rotation 360°.

JCP.402 - 425 X 300 CM



max. 58 km/h, 36 mph

UFJCP.402 FRAME

	A01 white		A02 silver
	A10 cappuccino		A12 alu teak
	A31 charcoal		

MIX & MATCH

UCJCP.402 CANOPY

	C003 pearl		C011 cotton
	C100 ice		C107 mooncrest
	C207 onyx		C210 pitch
	C305 umber		

Free pick: other fabrics on demand

UBJCP.4S BASE

	S01 white		S02 silver
	S31 charcoal		

UBIGB-JCP.4S-5S-6S in ground base /
UBOGB-JCP.4S-5S-6S on ground base

COVER

	UPJCP.4S-X77 black
--	--------------------

53 kg, 116.8 lbs nett
excl. base

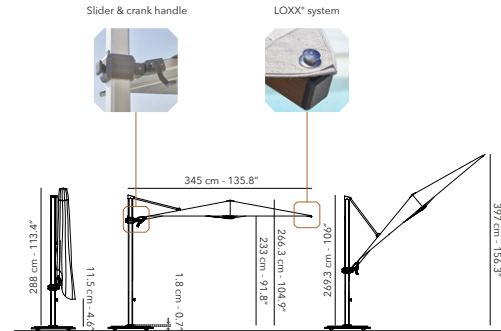

All dimensions exclude the base.

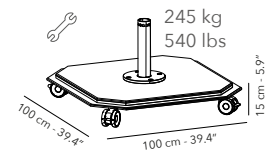
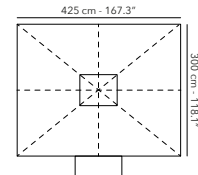
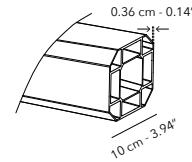

Hot galvanized steel plates, powder coated.
Four mounted wheels that rotate 360°, each with a brake.
Has the same colour as its frame.
An alu teak or cappuccino frame has a charcoal base.

Free pole frame, powder coated aluminium.
 Canopy 100% solution dyed acrylic, 320 gr/m².
 Tilt in height, left and right, rotation 360°.

JCP.4 SERIES

JCP.403 - Ø 400 CM



max. 58 km/h, 36 mph

UFJCP.403 FRAME

	A01 white		A02 silver
	A10 cappuccino		A12 alu teak
	A31 charcoal		

MIX & MATCH

UCJCP.403 CANOPY

	C003 pearl		C011 cotton
	C100 ice		C107 mooncrest
	C207 onyx		C210 pitch
	C305 umber		

Free pick: other fabrics on demand

UBJCP.45 BASE

	S01 white		S02 silver
	S31 charcoal		

UBIGB-JCP.45-55-65 in ground base /
 UBOGB-JCP.45-55-65 on ground base

COVER

	UPJCP.45-X77 black
--	--------------------

53 kg, 116.8 lbs nett
 excl. base

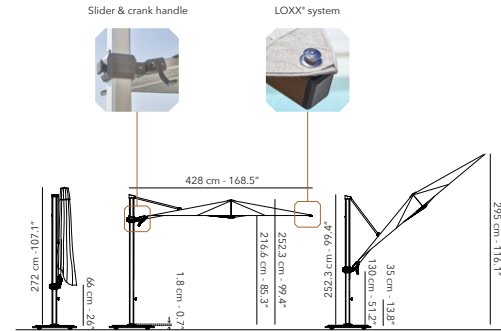

All dimensions exclude the base.

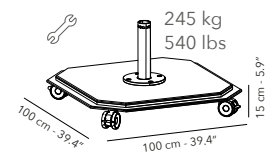
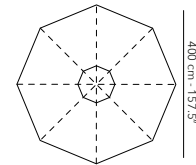
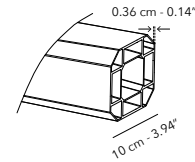

Hot galvanized steel plates, powder coated.
 Four mounted wheels that rotate 360°, each with a brake.
 Has the same colour as its frame.
 An alu teak or cappuccino frame has a charcoal base.

JCP.4 SERIES

Free pole frame, powder coated aluminium.
Canopy 100% solution dyed acrylic, 320 gr/m².
Tilt in height, left and right, rotation 360°.

JCP.404 - 250 X 350 CM



max. 58 km/h, 36 mph

UFJCP.404 FRAME

	A01 white		A02 silver
	A10 cappuccino		A12 alu teak
	A31 charcoal		

MIX & MATCH

UCJCP.404 CANOPY

	C003 pearl		C011 cotton
	C100 ice		C107 mooncrest
	C207 onyx		C210 pitch
	C305 umber		

Free pick: other fabrics on demand

UBJCP.4S BASE

	S01 white		S02 silver
	S31 charcoal		

UBIGB-JCP.4S-5S-6S in ground base /
UBOGB-JCP.4S-5S-6S on ground base

COVER

	UPJCP.4S-X77 black
--	--------------------

60 kg, 132.3 lbs nett
excl. base

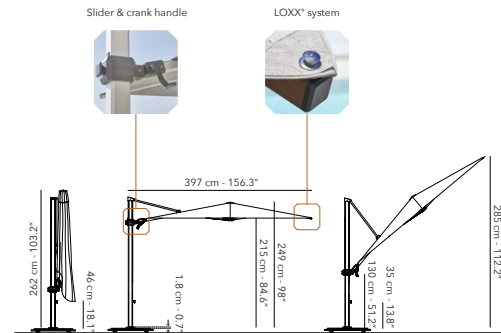

All dimensions exclude the base.

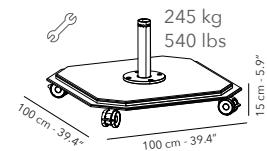
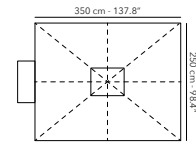
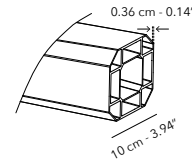

Hot galvanized steel plates, powder coated.
Four mounted wheels that rotate 360°, each with a brake.
Has the same colour as its frame.
An alu teak or cappuccino frame has a charcoal base.



JCP.5 SERIES

Free pole frame, powder coated aluminium.
Canopy 100% solution dyed acrylic, 320 gr/m².
Tilt in height, left and right, rotation 360°.

JCP.501 - 4* 300 X 300 CM



max. 58 km/h, 36 mph

UFJCP.501 FRAME

	A02 silver		A12 alu teak
	A31 charcoal		

143.5 kg, 316.4 lbs nett
excl. base

MIX & MATCH

UCJCP.501 CANOPY

	C003 pearl		C011 cotton
	C100 ice		C107 mooncrest
	C207 onyx		C210 pitch
	C305 umber		

Free pick: other fabrics on demand

UBJCP.5S-6S BASE

	S02 silver		S31 charcoal
--	------------	--	--------------

UBIGB-JCP.4S-5S-6S in ground base /
UBOGB-JCP.4S-5S-6S on ground base

COVER

	UPJCP.5S-X77 black
--	--------------------

UAJCP.5S GUTTERS

A fabric from our fast stock

Other fabric of your choice

Slider & crank handle



LOXX® system

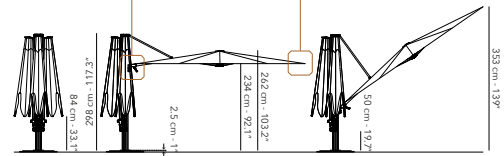

All dimensions exclude the base.

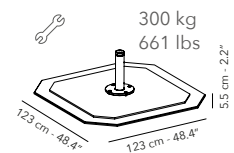
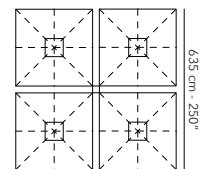
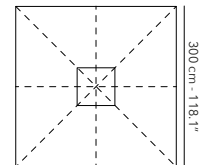
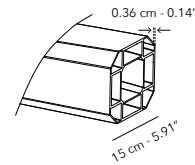

Hot galvanized steel plates, powder coated.
Base without wheels.
Has the same colour as its frame.
An alu teak frame has a charcoal base.

Free pole frame, powder coated aluminium.
 Canopy 100% solution dyed acrylic, 320 gr/m².
 Tilt in height, left and right, rotation 360°.

JCP.6 SERIES

JCP.601 - 2* 300 X 300 CM



max. 58 km/h, 36 mph

UFJCP.601 FrAME

	A10 cappuccino		A12 alu teak
	A31 charcoal		

MIX & MATCH

UCJCP.601 CANOPY

	C003 pearl		C011 cotton
	C100 ice		C107 mooncrest
	C207 onyx		C210 pitch
	C305 umber		

Free pick: other fabrics on demand

UBJCP.5S-6S BASE

	S31 charcoal		
--	--------------	--	--

UBIGB-JCP.4S-5S-6S in ground base /
 UBOGB-JCP.4S-5S-6S on ground base

COVER

	UPJCP.6S-X77 black		
--	--------------------	--	--

86.5 kg, 190.7 lbs nett
 excl. base

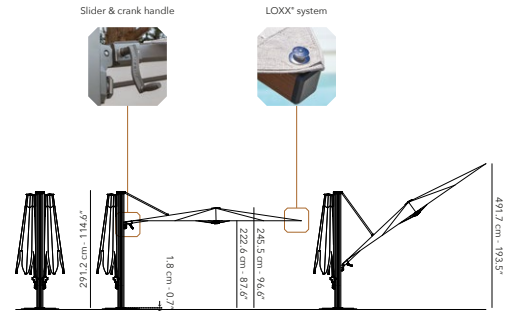

All dimensions exclude the base.

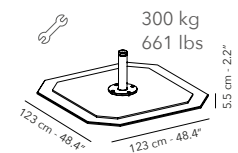
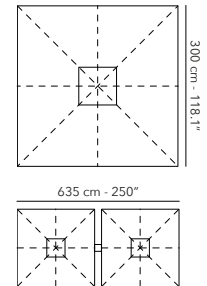
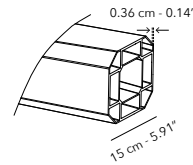

Hot galvanized steel plates, powder coated.
 Base without wheels.
 Has the same colour as its frame.
 An alu teak or cappuccino frame has a charcoal base.

AZORE

UPDATED with base plate

Free pole frame, powder coated aluminium.
Canopy is weatherproof and colour resistant.
Tilt in height, left and right, rotation 360°.

AZORE fully assembled (excl. base)



max. 27 km/h, 17 mph

UMAZO FRAME & CANOPY

		A01C101 white & cloud
		A30C204 anthracite & night
		A32C208 black & black

UB BASE

	AZO-125CA-G04 azore
--	---------------------

IGB-AZO-4G-MEDIUM in ground base

OGB-AZO-4G-MEDIUM on ground base

UP COVER

AZO-M-X75 grey

UA ACCESSORIES

LUN-LED02 Luna LED light

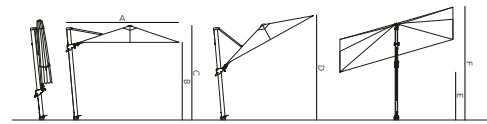
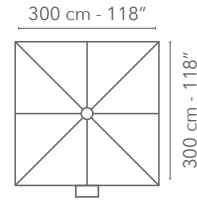

300 X 300 CM

	27 kg - 59.5 lbs nett excl. base
A	375 cm - 147.6"
B	203 cm - 79.9"
C	262 cm - 103.1"
D	355 cm - 139.8"
E	130 cm - 51.2"
F	300 cm - 118.1"



300 x 300 cm

Free pole frame, powder coated aluminium.
 Canopy is weatherproof and colour resistant.
 Tilt in height, left and right, rotation 360°.

ANTEGO

ANTEGO



max. 39 km/h, 24 mph

UFANT Frame

	A01 white		A03 linen
	A12 alu teal		A14 lava
	A30 anthracite		A32 black

UCANT CANOPY

	C001 natural		C010 latte
	C101 cloud		C106 gris nature
	C204 night		C208 black
	C211 steel		C212 gasoline
	C301 taupe		C304 walnut

Free pick: other fabrics on demand

UB BASE

	ANT-125-B01 white concrete
	ANT-125-B03 linen concrete
	ANT-125-B32 black concrete
	ANT-125CA-G04 silk grey granite
OPTIONAL	ANT-EW60-G04 silk grey granite tiles
	ANT-125-G13 sandstone
	ANT-125-G32 black granite

IGB-FP-5G-MEDIUM in ground base

OGB-FP-5G-MEDIUM on ground base

UP COVER

ANT-M-X75 grey

UA ACCESSORIES

LUN-LED02 Luna LED light

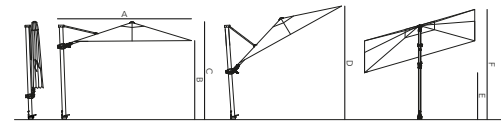
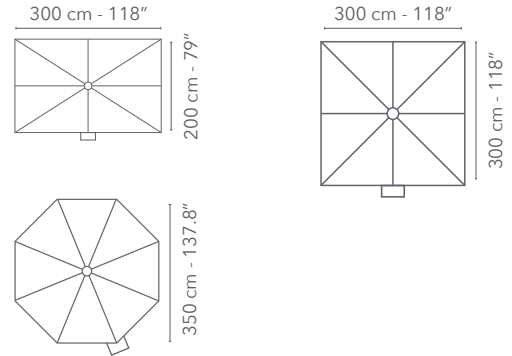

	300 X 200 CM	300 X 300 CM	Ø 350 CM
	33 kg - 72.8 lbs nett excl. base	34 kg - 75 lbs nett excl. base	35 kg - 77.1 lbs nett excl. base
A	275 cm - 108.3"	375 cm - 147.6"	427 cm - 168.1"
B	203 cm - 79.9"	203 cm - 79.9"	188 cm - 74"
C	262 cm - 103.1"	262 cm - 103.1"	261 cm - 102.8"
D	280 cm - 110"	355 cm - 139.8"	441 cm - 173.6"
E	130 cm - 51.2"	130 cm - 51.2"	130 cm - 51.2"
F	300 cm - 118.1"	300 cm - 118.1"	375 cm - 92.5"



LIMA

UPDATED

Free pole frame, powder coated aluminium.
Canopy is weatherproof and colour resistant.
Tilt in height, rotation 360°.

LIMA



max. 45 km/h, 28 mph

UFLIM FRAME

	A01 white		A03 linen
	A30 anthracite		A32 black

UCLIM CANOPY

	C001 natural		C010 latte
	C101 cloud		C106 gris nature
	C204 night		C208 black
	C211 steel		C212 gasoline
	C301 taupe		C304 walnut

Free pick: other fabrics on demand

UB BASE

	LIM-300-G04 silk grey granite
--	-------------------------------

IGB-FP-LARGE in ground base

OGB-FP-LARGE on ground base

UP COVER

LIM-L-X75 grey

UA ACCESSORIES

LUN-LED02 Luna LED light

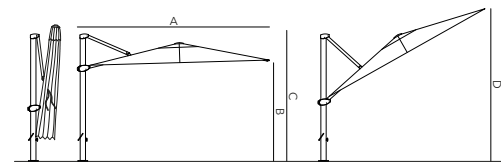
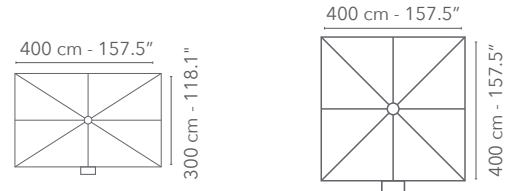

	400 X 300 CM	400 X 400 CM
	46 kg - 101.4 lbs nett excl. base	54 kg - 119 lbs nett excl. base
A	364 cm - 106.7"	464 cm - 182.7"
B	240 cm - 94.5"	240 cm - 94.5"
C	290 cm - 114.2"	290 cm - 114.2"
D	384 cm - 151.2"	364 cm - 143.3"

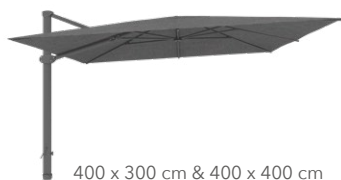

400 x 300 cm & 400 x 400 cm

Mid pole frame, powder coated aluminium with locking pins.
Flexible rib ends in fiber glass.
Diameter of the pole: 38 mm, 1.5".

TULI
NEW

max. 65 km/h, 40.4 mph

TULI

UMTUL FRAME & CANOPY

	A03C010 linen & latte
	A12C001 alu teak & natural
	A30C212 anthracite & gasoline

UB BASE

	TUL-50-B01 tuli round white
	TUL-50-B32 tuli round black
	ELB-44-S01 elba medium white
	ELB-44-S03 elba medium linen
	ELB-44-S31 elba medium charcoal
	LUC-60-B01 lucca heavy white
	LUC-60-B06 lucca heavy hazel
	LUC-60-B30 lucca heavy anthracite
OPTIONAL	UALUC-WHE.60 lucca heavy wheels

IGB-MP-SM in ground base*

BS-MP-SMALL beach spike

UP COVER

UMB-S-X75 grey

*Locking only possible under slider.

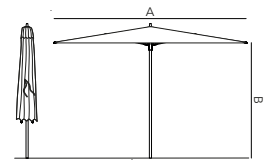
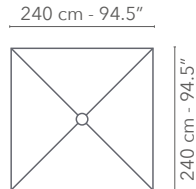

	240 X 240 CM
	5.5 kg - 12.1 lbs nett excl. base
A	240 cm - 94.5"
B	204 cm - 80.3"
C	230.6 cm - 90.8"



240 x 240 cm





AMALFI

Mid pole frame, powder coated aluminium.
Canopy is weatherproof and colour resistant.
Diameter of the pole: \varnothing 40 mm, 1.6".











AMALFI

max. 39 km/h, 24 mph

UFAMA FRAME







	A01 white		A03 linen
	A12 alu teal		A30 anthracite
	A32 black		

UCAMA CANOPY

	C001 natural		C010 latte
	C101 cloud		C106 gris nature
	C204 night		C208 black
	C211 steel		C212 gasoline
	C301 taupe		C304 walnut

Free pick: other fabrics on demand

UB BASE

	ELB-44-S01 elba medium white
	ELB-44-S03 elba medium linen
	ELB-44-S31 elba medium charcoal
	LUC-60-B01 lucca heavy white
	LUC-60-B06 lucca heavy hazel
	LUC-60-B30 lucca heavy anthracite
OPTIONAL	UALUC-WHE.60 lucca heavy wheels

IGB-MP-SM in ground base

UP COVER

AMA-M-X75 grey

UA ACCESSORIES

LUN-LED02 Luna LED light

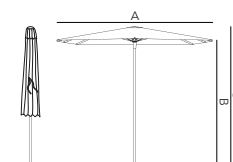
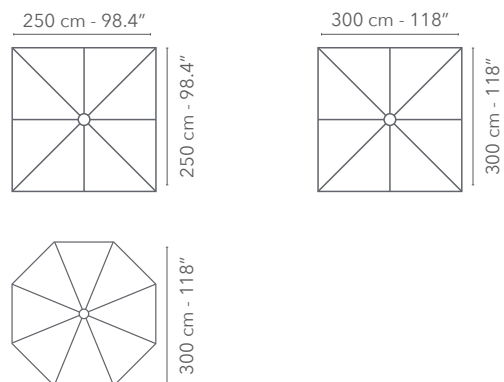

	250 X 250 CM	300 X 300 CM	\varnothing 300 CM
	15 kg - 33.1 lbs nett excl. base	16 kg - 35.2 lbs nett excl. base	16 kg - 35.2 lbs nett excl. base
A	250 cm - 98.4"	300 cm - 118.1"	300 cm - 118.1"
B	216 cm - 85"	216 cm - 85"	216 cm - 85"
C	250 cm - 98.4"	250 cm - 98.4"	250 cm - 98.4"



Free pole frame, powder coated aluminium.
Canopy is weatherproof and colour resistant.
Diameter of the pole: \varnothing 38 mm, 1.5".

MALIBU



max. 17 km/h, 10.6 mph

MALIBU fully assembled (excl. base)

UMMAL FRAME & CANOPY

		A01C002 white & white
		A01C105 white & light grey
		A12C002 alu teal & white*
		A12C109 alu teal & speckle*
		A30C105 anthracite & light grey
		A30C109 anthracite & speckle
		A30C200 anthracite & dark grey
		A30C302 anthracite & mocca
		A32C209 black & coal

*Only available in \varnothing 300 cm, 250 x 200 cm, 240 x 240 cm.

UB BASE

	LUC-25-B01 lucca half white
	LUC-25-B30 lucca half anthracite
	LUC-35-B01 lucca light white
	LUC-35-B06 lucca light hazel
	LUC-35-B30 lucca light anthracite
OPTIONAL	UALUC-WHE.35 lucca light wheels
	ELB-28-S01 elba light white
	ELB-28-S03 elba light linen
	ELB-28-S31 elba light charcoal

IGB-MP-SMALL in ground base

UP COVER

UMB-S-X75 grey

UA ACCESSORIES

LUN-LED02 Luna LED light

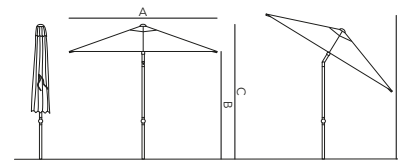
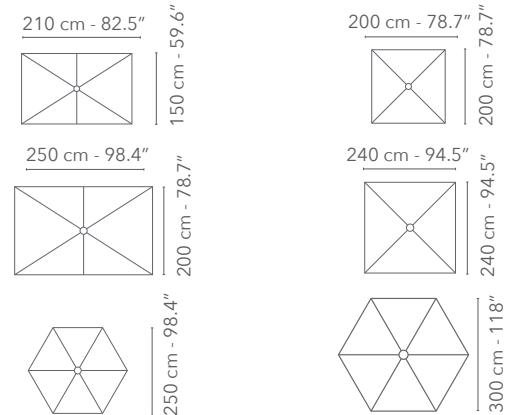

	210 X 150 CM	200 X 200 CM	\varnothing 250 CM
	4.4 kg - 9.7 lbs nett excl. base	4.2 kg - 9.3 lbs nett excl. base	5 kg - 11 lbs nett excl. base
A	210 cm - 82.7"	200 cm - 78.7"	250 cm - 98.4"
B	195 cm - 76.8"	195 cm - 76.8"	195 cm - 76.8"
C	255 cm - 100.4"	255 cm - 100.4"	255 cm - 100.4"
D	245 cm - 96.5"	253 cm - 99.6"	255 cm - 100.4"

	250 X 200 CM	240 X 240 CM	\varnothing 300 CM
	5 kg - 11 lbs nett excl. base	6.4 kg - 14.1 lbs nett excl. base	5.6 kg - 12.3 lbs nett excl. base
A	250 cm - 98.4"	240 cm - 94.5"	300 cm - 118.1"
B	195 cm - 76.8"	195 cm - 76.8"	195 cm - 76.8"
C	255 cm - 100.4"	255 cm - 100.4"	255 cm - 100.4"
D	255 cm - 100.4"	260 cm - 102.4"	275 cm - 108.3"



CUBA

Mid pole frame, eucalyptus wood.
Canopy is weatherproof and colour resistant.
Diameter of the pole: \varnothing 61 mm, 2.4".











CUBA

max. 39 km/h, 24.2 mph

UFCUB FRAME







	W60 eucalyptus
---	-----------------------

UCCUB CANOPY

	C001 natural		C101 cloud
	C106 gris nature		C204 night
	C208 black		C301 taupe
	C010 latte		C211 steel
	C304 walnut		C212 gasoline

Free pick: other fabrics on demand

UB BASE

	LUC-60-B01 lucca heavy white
	LUC-60-B06 lucca heavy hazel
	LUC-60-B30 lucca heavy anthracite
OPTIONAL	UALUC-WHE.60 lucca light wheels
	ELB-84-S01 elba heavy white
	ELB-84-S03 elba heavy linen
	ELB-84-S31 elba heavy charcoal

IGB-MP-LARGE in ground base

FFP-MP-LARGE on ground base

UP COVER

CUB-M

300 cm - 118.1"

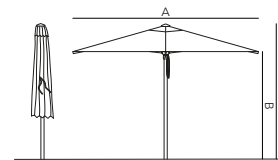
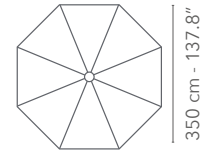
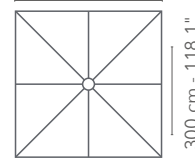

	300 X 300 CM	\varnothing 350 CM
	22 kg - 48.5 lbs nett excl. base	19 kg - 41.9 lbs nett excl. base
A	300 cm - 118.1"	350 cm - 137.8"
B	265 cm - 104.3"	234 cm - 92.1"
C	300 cm - 118.1"	365 cm - 143.7"



300 x 300 cm



\varnothing 350 cm

Mid pole frame, teak scratched.
 Canopy is weatherproof and colour resistant.
 Diameter of the pole: ø 61 mm, 2.4".
 Frame & canopy are supplied seperately to avoid stains.

MOOREA













max. 39 km/h, 24.2 mph

MOOREA

UFMOO FRAME







	W63 teak scratched
---	---------------------------

UCCUB CANOPY

	C001 natural		C101 cloud
	C106 gris nature		C204 night
	C208 black		C301 taupe
	C010 latte		C211 steel
	C304 walnut		C212 gasoline

Free pick: other fabrics on demand

UB BASE

	LUC-60-B01 lucca heavy white
	LUC-60-B06 lucca heavy hazel
	LUC-60-B30 lucca heavy anthracite
OPTIONAL	UALUC-WHE.60 lucca light wheels
	ELB-84-S01 elba heavy white
	ELB-84-S03 elba heavy linen
	ELB-84-S31 elba heavy charcoal

IGB-MP-LARGE in ground base

FFP-MP-LARGE on ground base

UP COVER

CUB-M

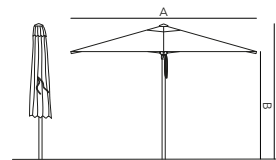
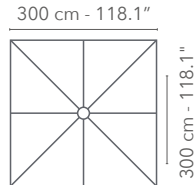

300 X 300 CM

	28 kg - 61.7 lbs nett excl. base
A	300 cm - 118.1"
B	238 cm - 93.7"
C	272 cm - 107.1"



300 x 300 cm

BASES

UBAZO-125CA SILK GREY GRANITE *Azore*

	125 kg, 275.6 lbs 80 x 80 x 5.5 cm, 31.5 x 31.5 x 2.2"
	G04 light grey granite, bush hammered wheels included

UBLIM-300 LIMA *Lima*

	300 kg, 661.4 lbs 100 x 100 x 10 cm, 39.4 x 39.4 x 4" tube: ø 45 mm, 1.7"
	G04 light grey granite, bush hammered wheels included

UBANT-125 CONCRETE *Antego*

	125 kg, 275.6 lbs 92.5 x 92.5 x 5 cm, 36.4 x 36.4 x 2"
	B01 white, B03 linen, B32 black concrete
	wheels included

UBTUL-50 TULI ROUND *Tuli*

	50 kg, 110.2 lbs ø 60 x 9 cm, 23.6 x 9.5" tube: ø 40 mm
	B01 white, B32 black concrete

UBANT-125CA SILK GREY GRANITE *Antego*

	125 kg, 275.6 lbs 92.5 x 92.5 x 5 cm, 36.4 x 36.4 x 2"
	G04 light grey granite, bush hammered wheels included
	UBANT-EW60-G04 2 half tiles 2x 30 kg, 2x 66 lbs

UBELB-28 ELBA LIGHT *Malibu*

	32.5 kg, 71.7 lbs 49 x 49 x 1.6 cm, 19.3 x 19.3 x 0.6" tube: ø 45 mm, 1.8"
	S01 white, S03 linen, S31 charcoal metallised & powder coated steel
	wheels included

UBANT-125 SANDSTONE *Antego*

	125 kg, 275.6 lbs 92.5 x 92.5 x 5 cm, 36.4 x 36.4 x 2"
	G13 Egyptian sandstone with sandblasted finish wheels included

UBELB-44 ELBA MEDIUM *Amalfi*

	44 kg, 97 lbs 54.5 x 54.5 x 1.8 cm, 21.5 x 21.5 x 0.7" tube: ø 55 mm, 2.2" adaptor ring: ø 40 mm, 1.6"
	S01 white, S03 linen, S31 charcoal metallised & powder coated steel
	wheels included

UBANT-125 BLACK GRANITE *Antego*

	125 kg, 275.6 lbs 92.5 x 92.5 x 5 cm, 36.4 x 36.4 x 2"
	G32 black granite, bush hammered wheels included

BASES

UBELB-84 ELBA HEAVY Cuba, Moorea

	<p>84 kg, 185.2 lbs 75.5 x 75.5 x 1.8 cm 29.7 x 29.7 x 0.7" tube: ø 65 mm, 2.6"</p>
	<p>S01 white, S03 linen, S31 charcoal metallised & powder coated steel</p> <p>wheels included</p>

UBLUC-25 LUCCA HALF Malibu

	<p>25 kg, 55.1 lbs 51 x 29 x 8 cm, 20 x 7 x 3.1" tube: ø 56 mm - 2.2"</p>
	<p>quick release system adaptor rings incl.: ø 18 - 50 mm, 0.7 - 2"</p> <p>B01 white, B30 anthracite concrete</p>

UBLUC-35 LUCCA LIGHT Malibu

	<p>35 kg, 77.2 lbs 45 x 45 x 8.5 cm, 17.7 x 17.7 x 3.3" tube: ø 56 mm - 2.2"</p>
	<p>quick release system adaptor rings incl.: ø 18 - 50 mm, 0.7 - 2"</p> <p>B01 white, B06 hazel, B30 anthracite concrete</p>
	<p>UALUC-WHE.35 Set 4 wheels 4x ø 50 mm, 2"</p>

UBLUC-60 LUCCA HEAVY Tuli, Amalfi, Cuba, Moorea

	<p>60 kg, 132.3 lbs 59 x 59 x 8 cm, 23.2 x 23.2 x 3.1" tube: ø 61 mm, 2.4"</p>
	<p>quick release system</p> <p>B01 white, B06 hazel, B30 anthracite concrete</p>
	<p>UALUC-WHE.60 Set 4 wheels 4x ø 50 mm, 2"</p>

IN GROUND BASE

UBBS-MP-SMALL MID POLE SMALL Tuli

	<p>beach spike aluminium</p>
--	----------------------------------

UBIGB-MP-SM MID POLE SMALL MEDIUM

Malibu, Amalfi, Tuli

	<p>aluminium</p>
--	------------------

UBIGB-MP-LARGE MID POLE LARGE Cuba, Moorea

	<p>15 kg, 33 lbs ø 7 x 67 cm, 2.8 x 26.4" steel</p>
--	---

UBIGB-AZO-4G-MEDIUM AZORE Azore

	<p>5.7 kg, 12.6 lbs ø 14.5 x 50 cm, 5.5 x 19.7" steel</p>
--	---

UBIGB-FP-5G-MEDIUM ANTEGO Antego

	<p>5.7 kg, 12.6 lbs ø 21.5 x 50 cm, 8.5 x 19.7" steel</p>
---	---

UBIGB-FP-LARGE LIMA Lima

	<p>8.4 kg, 18.5 lbs ø 21.5 x 50 cm, 8.5 x 19.7" steel</p>
--	---

ON GROUND BASE

UBOGB-MP-LARGE MID POLE LARGE Cuba, Moorea

	<p>8.4 kg, 18.5 lbs 30 x 30 x 44 cm, 11.8 x 11.8 x 17.3" anodised aluminium</p>
--	---

UBOGB-AZO-4G-MEDIUM MID POLE MEDIUM Azore

	<p>8 kg, 17.6 lbs ø 17 x 1.2 cm, 6.7 x 0.4" steel</p>
--	---

UBOGB-FP-5G-MEDIUM FREE POLE M. Antego

	<p>8 kg, 17.6 lbs ø 17 x 1.2 cm, 6.7 x 0.4" steel</p>
--	---

UBOGB-FP-LARGE FREE POLE LARGE Lima

	<p>8 kg, 17.6 lbs ø 21.5 x 1.2 cm, 8.5 x 0.5" steel</p>
--	---

TONDO

NEW

Powder coated aluminium frame with multicoloured rope 30 mm.
Cushions are weatherproof and colour resistant.
Table top is made of solid teak or ceramic 12 mm.

LOUNGE CHAIR 1S

NEW

		FUTON1S09 frame		A03R05 linen & seal
	QUICK DRY	CUTON1S09 cushions		C016 pampas cat. C
	COMFORT	CUTON1S09-CF cushions		C016 pampas cat. C 

 33.2 kg
60 lbs

360° rotation through the swivel system.
Other fabrics upon request.
Find an overview on p. 254.
Protection cover available.

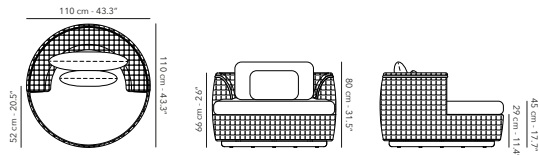

SOFA 3S

NEW

		FUTON3S08 frame		A03R05 linen & seal
	QUICK DRY	CUTON3S08 cushions		C016 pampas cat. C
	COMFORT	CUTON3S08-CF cushions		C016 pampas cat. C 



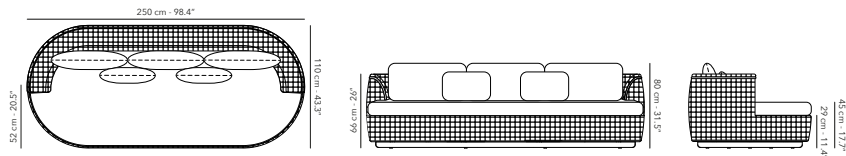

 65.5 kg
144.4 lbs

Other fabrics upon request.
Find an overview on p. 254.
Protection cover available.



MODULAR ORGANIC SOFA ISLAND left arm

NEW

		FUTONSIO1LA frame		A03R05 linen & seal
	QUICK DRY	CUTONSIO1LA cushions		C016 pampas cat. C
	COMFORT	CUTONSIO1LA-CF cushions		C016 pampas cat. C 

 54.7 kg
120.6 lbs

Other fabrics upon request.
Find an overview on p. 254.
Protection cover available.

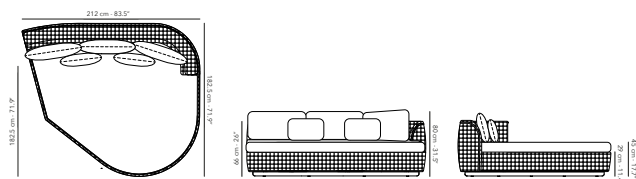

TONDO

MODULAR ORGANIC SOFA ISLAND right arm

NEW

	QUICK DRY	FUTONSI01RA frame		A03R05 linen & seal	 54.7 kg 120.6 lbs
	COMFORT	CUTONSI01RA cushions		C016 pampas cat. C	
	COMFORT	CUTONSI01RA-CF cushions		C016 pampas cat. C 	

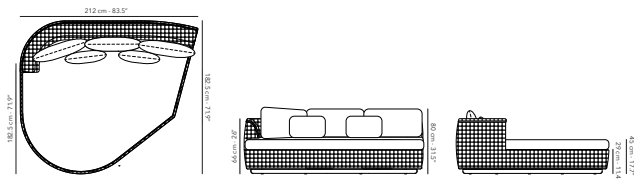

MODULAR ORGANIC SOFA 2.5S left arm

NEW

	QUICK DRY	FUTON2S09LA frame		A03R05 linen & seal	 45.4 kg 100.1 lbs
	COMFORT	CUTON2S09LA cushions		C016 pampas cat. C	
	COMFORT	CUTON2S09LA-CF cushions		C016 pampas cat. C 	

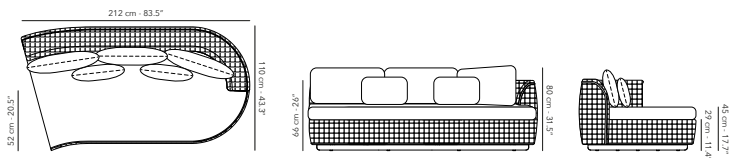

MODULAR ORGANIC SOFA 2.5S right arm

NEW



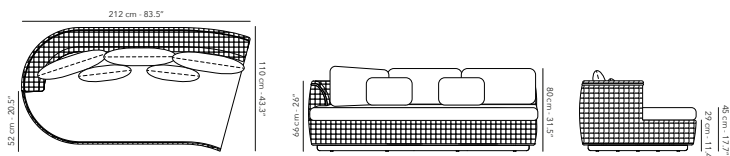

	QUICK DRY	FUTON2S09RA frame		A03R05 linen & seal	 45.4 kg 100.1 lbs
	COMFORT	CUTON2S09RA cushions		C016 pampas cat. C	
	COMFORT	CUTON2S09RA-CF cushions		C016 pampas cat. C 	



TONDO

COFFEE TABLE ø 110 cm

NEW

	FUTONLT11 frame	 	A03R05 linen & seal
	FUTONTOP11 table top		W62 teak
			K14 taupegrey





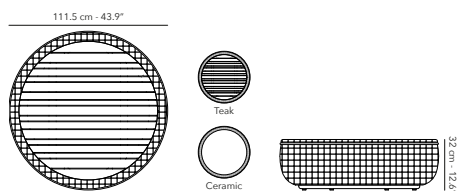

W62
21.3 kg
47 lbs



SIDE TABLE ø 45 cm

NEW

	FUTONST10 frame	 	A03R05 linen & seal
	FUTONTOP10 table top		W62 teak
			K14 taupegrey





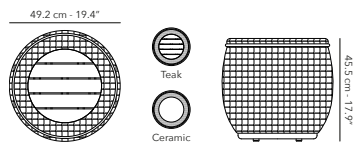

W62
6.9 kg
15.2 lbs



DAYBED

NEW

	FUTONDB04 frame	 	A03R05 linen & seal
	QUICK DRY CUTONDB04 cushions		C016 pampas cat. C
	COMFORT CUTONDB04-CF cushions		C016 pampas cat. C 



65.9 kg
145.3 lbs

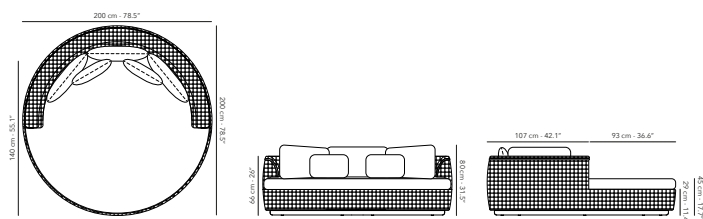

Other fabrics upon request.
Find an overview on p. 254.
Protection cover available.



TONDO

PRANA SMALL \varnothing 45 x 40 cm

NEW

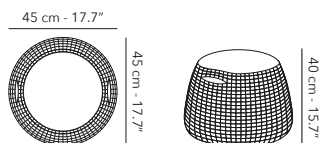

	<p>DEBASPRA.S frame</p>		<p>D05 seal</p>
---	-----------------------------	---	-----------------

4.4 kg
9.7 lbs



PRANA LARGE \varnothing 65 x 58 cm

NEW

	<p>DEBASPRA.L frame</p>		<p>D05 seal</p>
--	-----------------------------	---	-----------------

9.3 kg
20.5 lbs

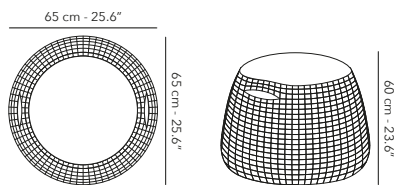

COMO

NEW

Eps finished with a mixture of chalk and concrete applied by hand and spatula.
 Table top 25 mm.
 Waterproof- & repellent.

ORGANIC DINING TABLE \varnothing 160 cm

NEW

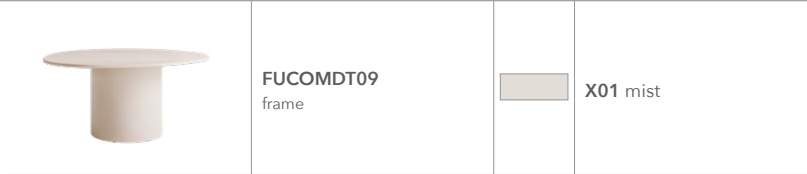

Protection cover available.

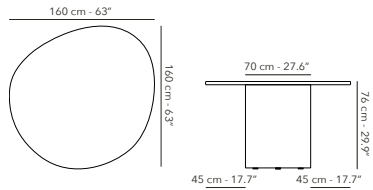

ORGANIC DINING TABLE 260 x 120 cm

NEW

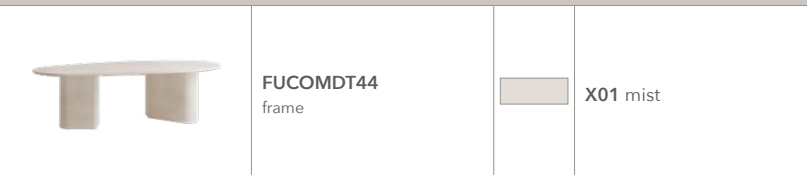

Protection cover available.

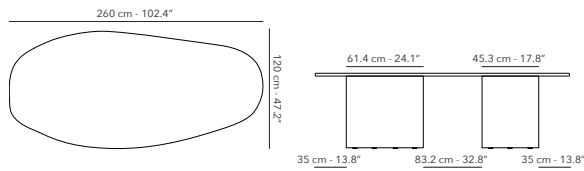

ROUND NESTING COFFEE TABLE \varnothing 90 cm

NEW

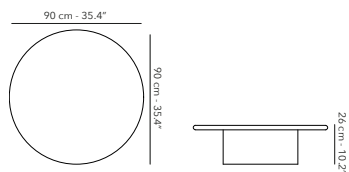
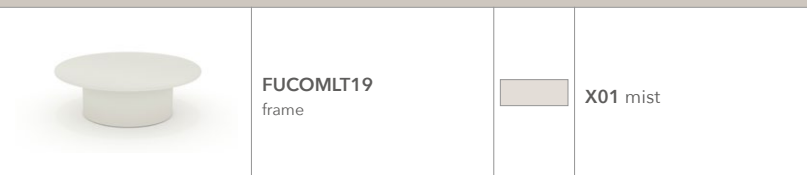

ORGANIC NESTING COFFEE TABLE 145 x 100 cm

NEW

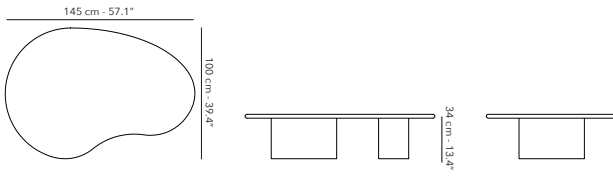
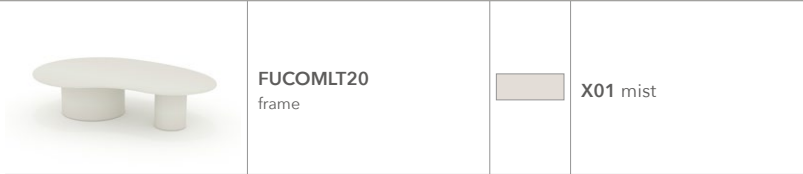

ORGANIC NESTING SIDE TABLE 50 x 40 cm

NEW

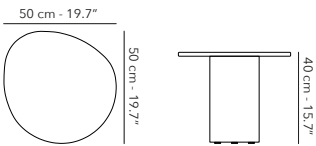
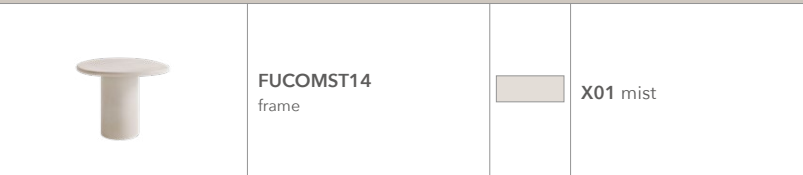

ORGANIC NESTING SIDE TABLE 50 x 50 cm

NEW

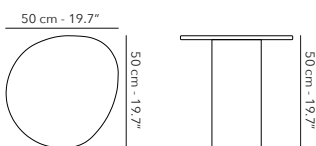
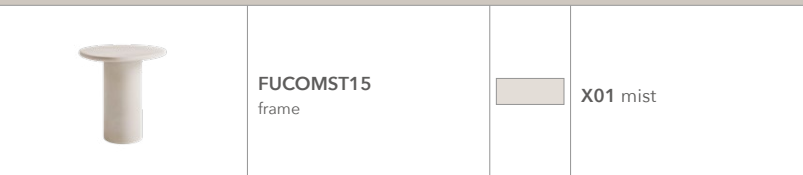







NOA

Designed by Enrique Marti

Teak frame with hand woven strap.
 Seat with teak.
 Cushions are weatherproof and colour resistant.
 Table top in solid teak.

DINING CHAIR

UPDATED WITH OPTIONAL BACK CUSHION

	FUNOANC08 frame		W62R11 teak & artichoke
	CUNOA(N)AC08 cushions	 	C015 brulé cat. D C111 truffle cat. D
	OPTIONAL CUNOABA(N)AC08 back cushion	 	C015 brulé cat. D C111 truffle cat. D







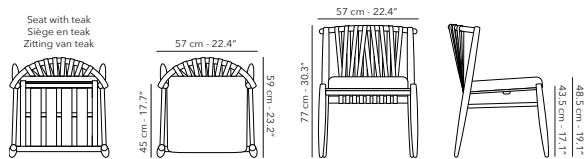

6.8 kg
15 lbs

Other fabrics upon request.
 Find an overview on p. 254.
 Protection cover available.



DINING ARMCHAIR

UPDATED WITH OPTIONAL BACK CUSHION

	FUNOAAC08 frame		W62R11 teak & artichoke
	CUNOA(N)AC08 cushions	 	C015 brulé cat. D C111 truffle cat. D
	OPTIONAL CUNOABA(N)AC08 back cushion	 	C015 brulé cat. D C111 truffle cat. D



7.7 kg
17 lbs

Other fabrics upon request.
 Find an overview on p. 254.
 Protection cover available.

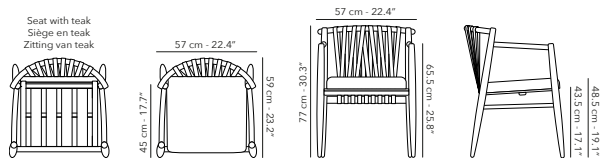



DINING TABLE 200 x 100 cm

	<p>FUNOADT43 frame</p>		<p>W62 teak</p>
---	-----------------------------------	---	------------------------

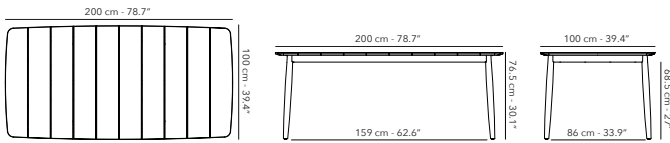

 49.5 kg
109.1 lbs



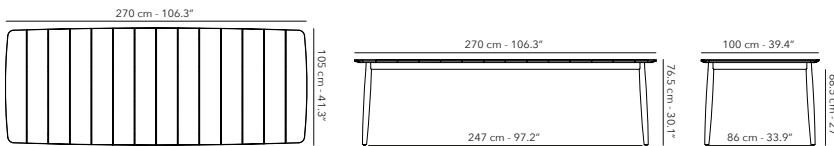

DINING TABLE 270 x 100 cm

	<p>FUNOADT46 frame</p>		<p>W62 teak</p>
--	-----------------------------------	--	------------------------



 72.4 kg
159.6 lbs



DINING TABLE 340 x 100 cm

	<p>FUNOADT50 frame</p>		<p>W62 teak</p>
---	-----------------------------------	---	------------------------

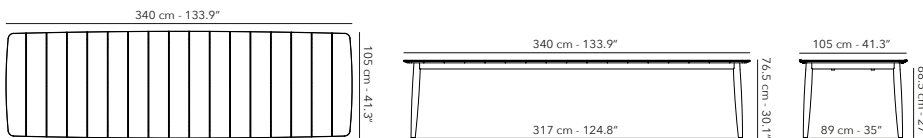
 103.9 kg
229.1 lbs



NOA

LOUNGE CHAIR 1S



COMFORT	FUNOA1S06 frame		W62R11 teak & artichoke
	QUICK DRY	CUNOA1S06 cushions	C015 brûlé cat. D
		CUNOA1S06-CF cushions	C111 truffe cat. D

20.2 kg
44.5 lbs

Other fabrics upon request.
Find an overview on p. 254.
Protection cover available.

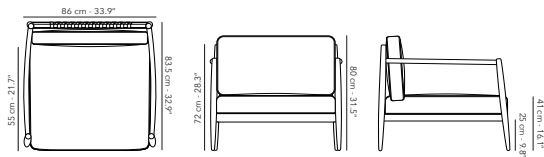

SOFA 2S



COMFORT	FUNOA2S06 frame		W62R11 teak & artichoke
	QUICK DRY	2x CUNOA1S06 cushions	C015 brûlé cat. D
		2x CUNOA1S06-CF cushions	C111 truffe cat. D

36.4 kg
80.3 lbs

Other fabrics upon request.
Find an overview on p. 254.
Protection cover available.

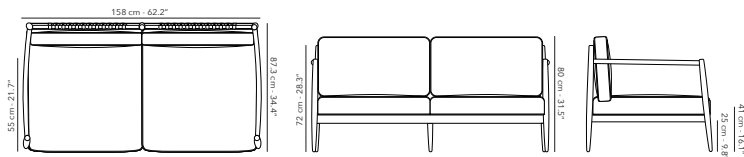

SOFA 3S



COMFORT	FUNOA3S06 frame		W62R11 teak & artichoke
	QUICK DRY	3x CUNOA1S06 cushions	C015 brûlé cat. D
		3x CUNOA1S06 cushions	C111 truffe cat. D

53.7 kg
118.4 lbs

Other fabrics upon request.
Find an overview on p. 254.
Protection cover available.

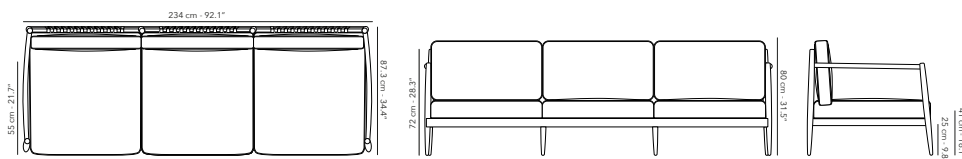

COFFEE TABLE 125 x 75 cm



FUNOALT10
frame



W62 teak



23.5 kg
51.8 lbs

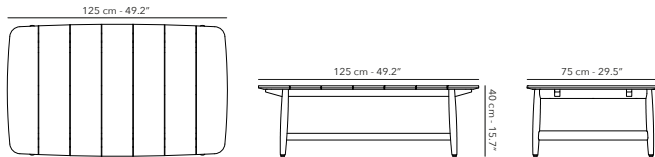

SIDE TABLE 50 x 50 cm



FUNOAST08
frame



W62 teak



6.4 kg
14.1 lbs

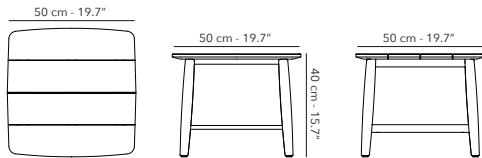

SOFA SIDE TABLE



FUNOASST01
frame



W62 teak



4.3 kg
9.5 lbs

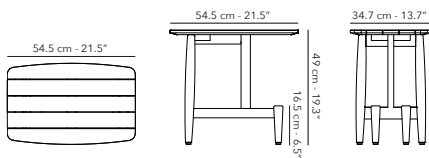

NOA

OTTOMAN

NEW

	<p>QUICK DRY</p> <p>COMFORT</p>	<p>FUNOAO02 frame</p>	 <p>W62 teak</p>	
		<p>CUNOAO02 cushions</p>	 <p>C015 brulé cat. D </p>  <p>C111 truffle cat. D </p>	
		<p>CUNOAO02-CF cushions</p>	 <p>C015 brulé cat. D</p>  <p>C111 truffle cat. D</p>	





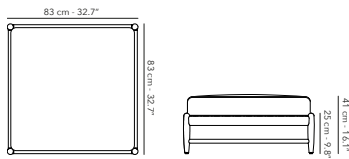

Other fabrics upon request.
Find an overview on p. 254.
Protection cover available.



CHAISE LONGUE left arm

NEW

	<p>QUICK DRY</p> <p>COMFORT</p>	<p>FUNOACL05LA frame</p>	 <p>W62R11 teak & artichoke</p>	
		<p>CUNOACL05LA cushions</p>	 <p>C015 brulé cat. D </p>  <p>C111 truffle cat. D </p>	
		<p>CUNOACL05LA-CF cushions</p>	 <p>C015 brulé cat. D</p>  <p>C111 truffle cat. D</p>	





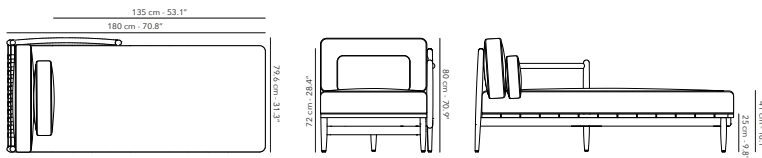





Other fabrics upon request.
Find an overview on p. 254.
Protection cover available.



CHAISE LONGUE right arm

NEW

	<p>QUICK DRY</p> <p>COMFORT</p>	<p>FUNOACL05RA frame</p>	 <p>W62R11 teak & artichoke</p>	
		<p>CUNOACL05RA cushions</p>	 <p>C015 brulé cat. D </p>  <p>C111 truffle cat. D </p>	
		<p>CUNOACL05RA-CF cushions</p>	 <p>C015 brulé cat. D</p>  <p>C111 truffle cat. D</p>	



Other fabrics upon request.
Find an overview on p. 254.
Protection cover available.

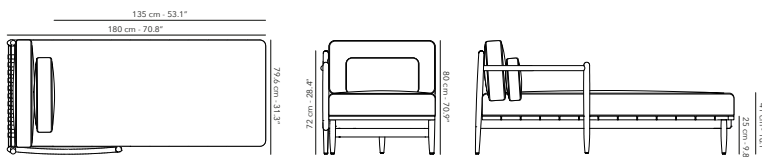

SUNLOUNGER

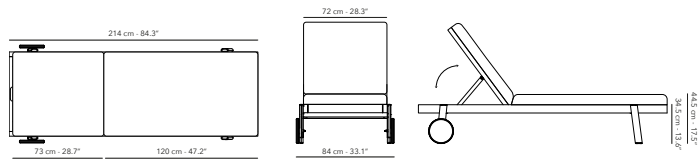

	<p>QUICK DRY</p>	<p>FUNOASL06 frame</p>	 <p>W62 teak</p>	
		<p>COMFORT</p>	<p>CUNOASL06-2.0 cushions</p>	 <p>C015 brûlé cat. D </p>  <p>C111 truffe cat. D </p>
			<p>CUNOASL06-2.0-CF cushions</p>	 <p>C015 brûlé cat. D</p>  <p>C111 truffe cat. D</p>

Other fabrics upon request.
Find an overview on p. 254.
Protection cover available.



DIVIDER H 150 cm

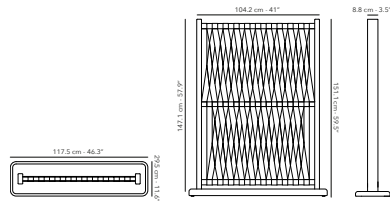

UPDATED DESIGN

	<p>FUNOADIV150 (low) frame</p>	 <p>W62R11 teak & artichoke</p>	<p>41.8 kg 92.2 lbs</p>
--	---	--	-----------------------------



DIVIDER H 180 cm

UPDATED DESIGN

	<p>FUNOADIV180 (high) frame</p>	 <p>W62R11 teak & artichoke</p>	<p>45.8 kg 100.9 lbs</p>
---	--	---	------------------------------

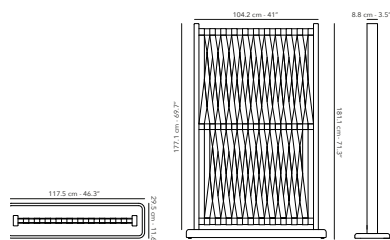

NERO

NEW

Black teak frame with hand woven rope.
Cushions are weatherproof and colour resistant.
Table top in solid teak.
Black teak care kit available.

DINING ARMCHAIR

	FUNERAC09 frame		W68R13 black teak & sand
	CUNERAC09 cushions		C015 brûlé cat. D
	CUNERBAAC09 back cushion		C015 brûlé cat. D
OPTIONAL 		C111 truffe cat. D	



UPDATED WITH OPTIONAL BACK CUSHION

 7 kg
15.4 lbs

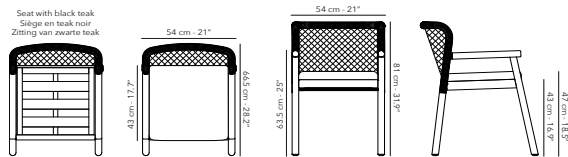
Other fabrics upon request.
Find an overview on p. 254.
Protection cover available.



DINING TABLE 240 x 100 cm

	FUNERDT44 frame		W68 black teak
--	---------------------------	--	-----------------------



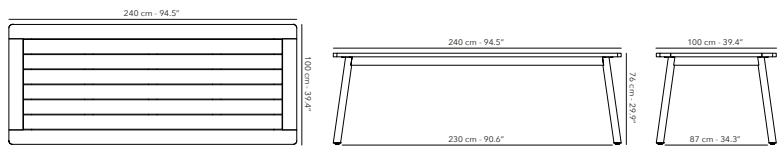

 62.2 kg
137.1 lbs

Protection cover available.



DINING TABLE 300 x 100 cm

	FUNERDT47 frame		W68 black teak
---	---------------------------	---	-----------------------



 76.8 kg
169.3 lbs

Protection cover available.

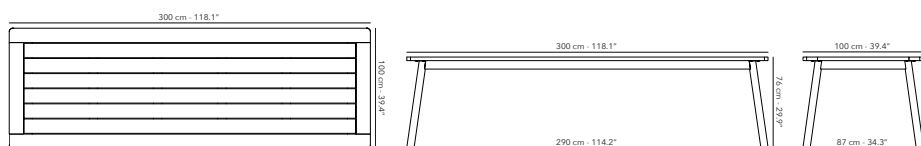

NERO

LOUNGE CHAIR 1S

		FUNER1S07 frame		W68R13 black teak & sand	
	QUICK DRY	CUNER1S07 cushions	 	C015 brûlé cat. D  C111 truffe cat. D 	
	COMFORT	CUNER1S07-CF cushions	 	C015 brûlé cat. D C111 truffe cat. D	

 15.1 kg
33.3 lbs

Other fabrics upon request.
Find an overview on p. 254.
Protection cover available.

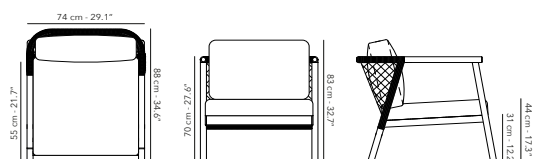

SOFA 2S







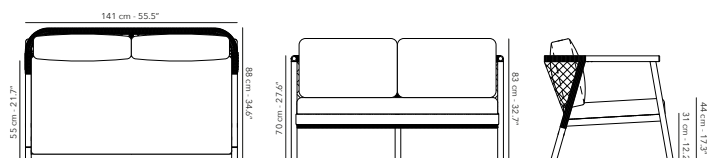

		FUNER2S07 frame		W68R13 black teak & sand	
	QUICK DRY	CUNER2S07 cushions	 	C015 brûlé cat. D  C111 truffe cat. D 	
	COMFORT	CUNER2S07-CF cushions	 	C015 brûlé cat. D C111 truffe cat. D	

 26.5 kg
58.4 lbs

Other fabrics upon request.
Find an overview on p. 254.
Protection cover available.



SOFA 3S

		FUNER3S07 frame		W68R13 black teak & sand	
	QUICK DRY	CUNER3S07 cushions	 	C015 brûlé cat. D  C111 truffe cat. D 	
	COMFORT	CUNER3S07-CF cushions	 	C015 brûlé cat. D C111 truffe cat. D	

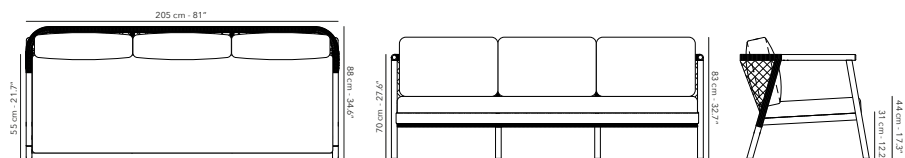

 37.7 kg
83.1 lbs

Other fabrics upon request.
Find an overview on p. 254.
Protection cover available.



NERO

COFFEE TABLE 120 x 80 cm

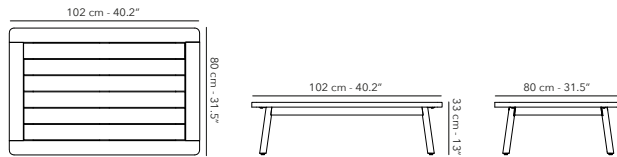

	FUNERLT10 frame		W68 black teak
---	---------------------------	---	-----------------------

20 kg
44 lbs



SIDE TABLE 45 x 45 cm





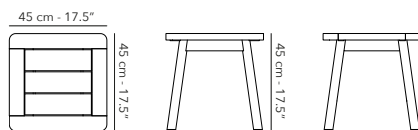

NEW

	FUNERST09 frame		W68 black teak
--	---------------------------	--	-----------------------

6.3 kg
13.9 lbs



SUNLOUNGER

	FUNERSL07 frame		W68R13 black teak & sand	
	QUICK DRY	CUNERSL07 cushions		C015 brulé cat. D 
		CUNERSL07-CF cushions		C111 truffle cat. D 
	COMFORT			C015 brulé cat. D

 35 kg
77.2 lbs



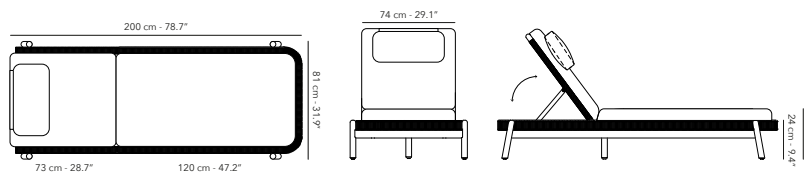



Other fabrics upon request.
Find an overview on p. 254.
Protection cover available.



Aluminium frame with hand woven rope.
Cushions are weatherproof and colour resistant.
Solid teak armrests on the lounge modules.

SCOOP

LOUNGE CHAIR 1S





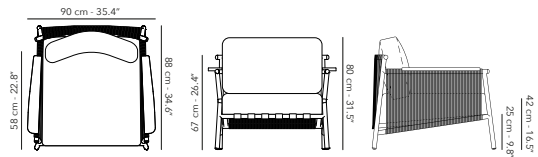

		FUSCO1S05 frame		A01R02 white silver	
				A14R14 lava brown	
	Q. DRY	CUSCO1S05 cushions		C007 beige cat. C	
	COMF.	CUSCO1S05-CF cushions		C007 beige cat. C	

16.5 kg
36.4 lbs

Other fabrics upon request.
Find an overview on p. 254.
Protection cover available.



SOFA 2S





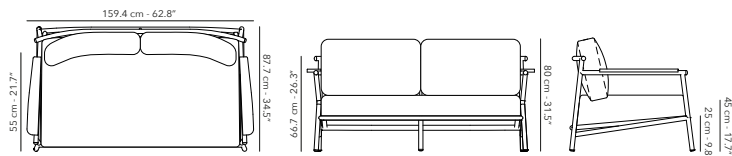

		FUSCO2S05 frame		A01R02 white silver	
				A14R14 lava brown	
	Q. DRY	CUSCO2S05 cushions		C007 beige cat. C	
	COMF.	CUSCO2S05-CF cushions		C007 beige cat. C	

28.5 kg
62.8 lbs

Other fabrics upon request.
Find an overview on p. 254.
Protection cover available.



SOFA 3S

		FUSCO3S05 frame		A01R02 white silver	
				A14R14 lava brown	
	Q. DRY	CUSCO3S05 cushions		C007 beige cat. C	
	COMF.	CUSCO3S05-CF cushions		C007 beige cat. C	





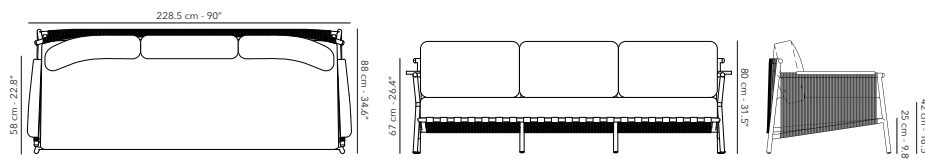

42.5 kg
93.7 lbs

Other fabrics upon request.
Find an overview on p. 254.
Protection cover available.



SCOOP

SUNLOUNGER

	FUSCOSL05 frame		A01R02 white silver
			A14R14 lava brown
	CUSCOSL05 cushions		C007 beige cat. C 
		CUSCOSL05-CF cushions	

19 kg
42 lbs



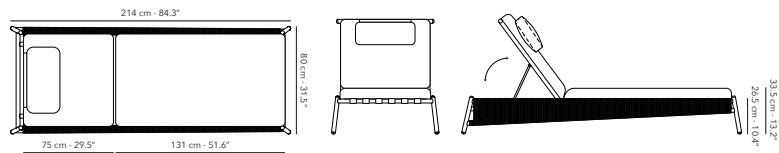





Other fabrics upon request.
Find an overview on p. 254.
Protection cover available.



Aluminium frame with hand woven wicker 6 mm.
 Seat with Essegomma strap 50 mm.
 Table top is made of (sable) solid teak or ceramic 12 mm.

TUGU
 UPDATED





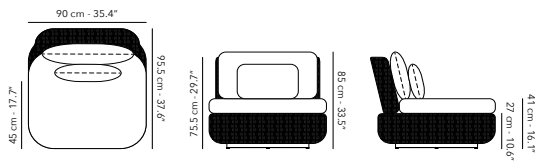

SOFA 1S

		FUTUG1S03 frame		F16 cottage	   30 kg 66 lbs
	Q. DRY	CUTUG1S03 cushions		C008 linen cat. B 	
	COMF.	CUTUG1S03-CF cushions		C008 linen cat. B	

360° rotation through the swivel system.
 Other fabrics upon request.
 Find an overview on p. 254.
 Protection cover available.







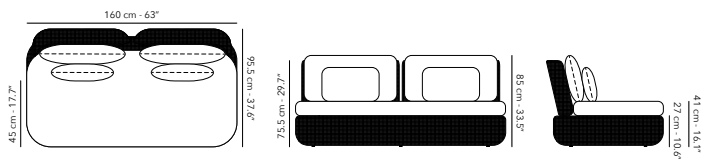

SOFA 2S

		FUTUG2S03 frame		F16 cottage	  41.5 kg 91.5 lbs
	Q. DRY	CUTUG2S03 cushions		C008 linen cat. B 	
	COMF.	CUTUG2S03-CF cushions		C008 linen cat. B	

Other fabrics upon request.
 Find an overview on p. 254.
 Protection cover available.



SOFA 3S



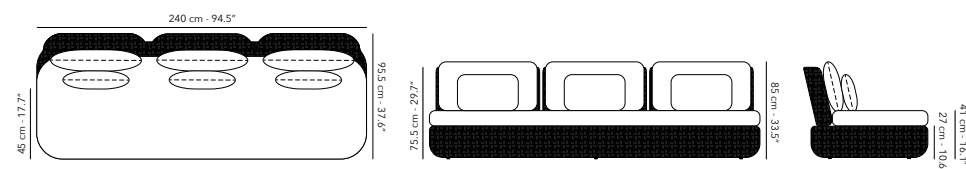

		FUTUG3S03 frame		F16 cottage	  60 kg 132.3 lbs
	Q. DRY	CUTUG3S03 cushions		C008 linen cat. B 	
	COMF.	CUTUG3S03-CF cushions		C008 linen cat. B	

Other fabrics upon request.
 Find an overview on p. 254.
 Protection cover available.



TUGU





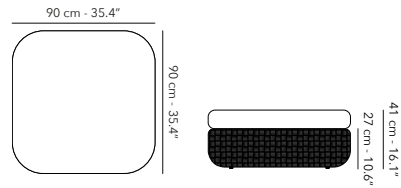

OTTOMAN 90 x 90 cm

		FUTUGOT01 frame		F16 cottage	
	Q. DRY	CUTUGOT01 cushions		C008 linen cat. B	
	COMF.	CUTUGOT01-CF cushions		C008 linen cat. B	

 13.7 kg
30.2 lbs







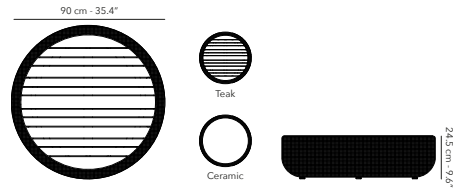

COFFEE TABLE ø 90 cm

		FUTUGLT08S frame		F16 cottage	 W62 & W64 13 kg 28.6 lbs
		FUTUGTOP04 table top		W62 teak	
				W64 sable teak	
				K14 taupegrey	





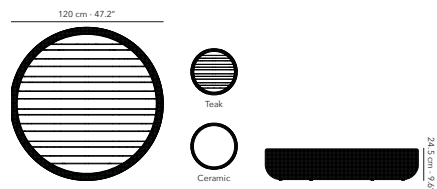

COFFEE TABLE ø 120 cm

		FUTUGLT07S frame		F16 cottage	 W62 & W64 19 kg 42 lbs
		FUTUGTOP06 table top		W62 teak	
				W64 sable teak	
				K14 taupegrey	



TUGU

SIDE TABLE ø 45 cm

	FUTUGST055 frame		F16 cottage
	FUTUGTOP05 table top		W62 teak
			W64 sable teak
			K14 taupegrey



W62 & W64
5.3 kg
11.6 lbs

45 cm - 17.7"



Teak







Ceramic



37 cm - 14.6"

SUNLOUNGER

	FUTUGSL02 frame		F16 cottage
	Q. DRY CUTUGSL02 cushions		C008 linen cat. B 
	COMF. CUTUGSL02-CF cushions		C008 linen cat. B





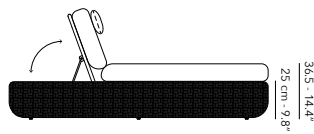
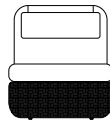
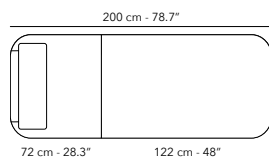

30 kg
66 lbs



DAYBED

NEW

	FUTUGDB05 frame		F16 cottage
	Q. DRY CUTUGDB05 cushions		C008 linen cat. B 
	COMF. CUTUGDB05-CF cushions		C008 linen cat. B



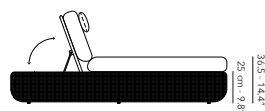
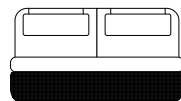
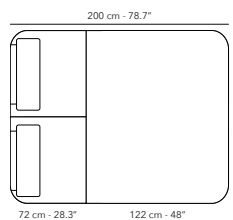

0 kg
0 lbs



TUGU

POTTERY SMALL ø 45 cm

NEW

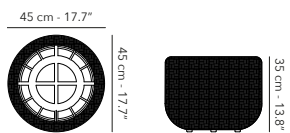

	<p>DEPOTTUG45.S frame</p>		<p>F16 cottage</p>
---	-------------------------------	---	--------------------

3.8 kg
8.4 lbs



POTTERY MEDIUM ø 65 cm

NEW

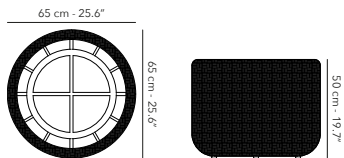

	<p>DEPOTTUG65.M frame</p>		<p>F16 cottage</p>
--	-------------------------------	---	--------------------

7.3 kg
16.1 lbs



POTTERY LARGE ø 85 cm

NEW

	<p>DEPOTTUG85.L frame</p>		<p>F16 cottage</p>
---	-------------------------------	---	--------------------

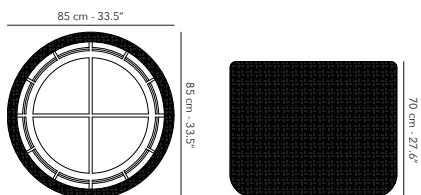

11.5 kg
25.4 lbs



(Sable) teak frame with hand woven rope 10 mm.
 Cushions are weatherproof and colour resistant.
 Table top is made of ceramic 12 mm.
 Teak care kit available.

LEGNA

DINING ARMCHAIR

	FULEGAC06 frame		W64R12 sable teak & cream
	CULEGAC06 cushions		C012 cream cat. C



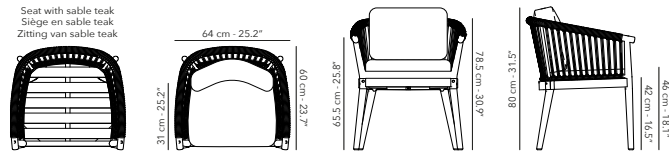

9.2 kg
 20.3 lbs

Other fabrics upon request.
 Find an overview on p. 254.
 Protection cover available.



LEGNA

DINING TABLE 160 x 100 cm





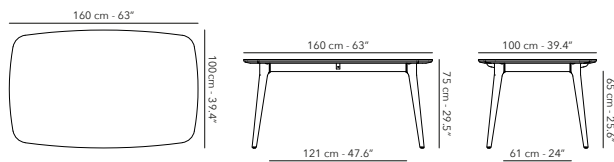

	FULEGDT41S frame		W64 sable teak
	FULEGTOP41 table top		K02 bianco
			K14 taupegrey
			K31 charcoal

 71.7 kg
158.1 lbs



DINING TABLE 240 x 100 cm

UPDATED





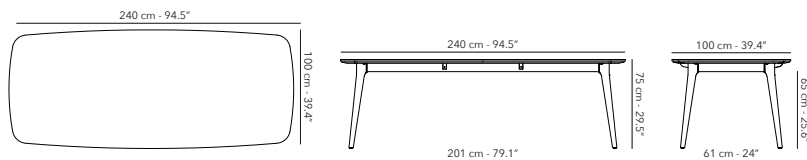

	FULEGDT44S frame		W62 teak
	FULEGTOP44 table top		W64 sable teak
			K02 bianco
			K14 taupegrey
			K31 charcoal

 100.2 kg
220.8 lbs



DINING TABLE 320 x 100 cm

UPDATED



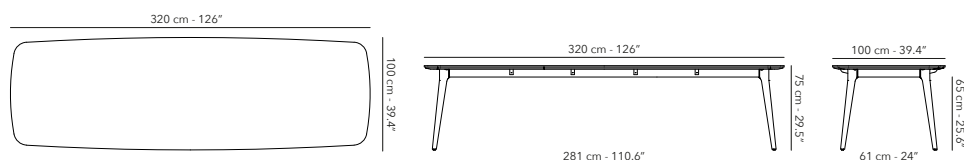

	FULEGDT49S frame		W62 teak
	FULEGTOP49 table top		W64 sable teak
			K02 bianco
			K14 taupegrey
			K31 charcoal

 128.3 kg
282.9 lbs



LEGNA



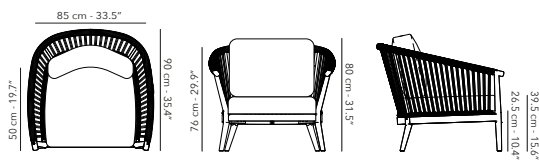

LOUNGE CHAIR 1S

		FULEG1S04 frame		W64R12 sable teak & cream	14 kg 31 lbs
	Q. DRY	CULEG1S04 cushions		C012 cream cat. C 	
	COMF.	CULEG1S04-CF cushions		C012 cream cat. C	

Other fabrics upon request.
Find an overview on p. 254.
Protection cover available.





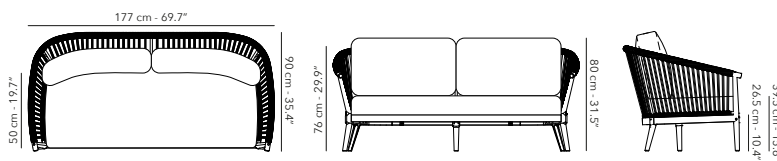

SOFA 2.5S

		FULEG2S04 frame		W64R12 sable teak & cream	28.6 kg 63 lbs
	Q. DRY	CULEG2S04 cushions		C012 cream cat. C 	
	COMF.	CULEG2S04-CF cushions		C012 cream cat. C	

Other fabrics upon request.
Find an overview on p. 254.
Protection cover available.



SOFA 3S

		FULEG3S04 frame		W64R12 sable teak & cream	33.5 kg 74 lbs
	Q. DRY	CULEG3S04 cushions		C012 cream cat. C 	
	COMF.	CULEG3S04-CF cushions		C012 cream cat. C	

Other fabrics upon request.
Find an overview on p. 254.
Protection cover available.

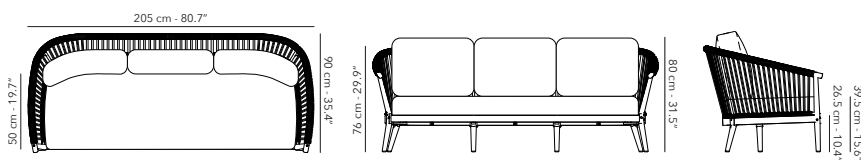

LEGNA

CHAISE LONGUE



		FULEGCL03 frame		W64R12 sable teak & cream	
	Q.DRY	CULEGCL03 cushions		C012 cream cat. C	
	COMF.	CULEGCL03-CF cushions		C012 cream cat. C	

25.6 kg
56.4 lbs

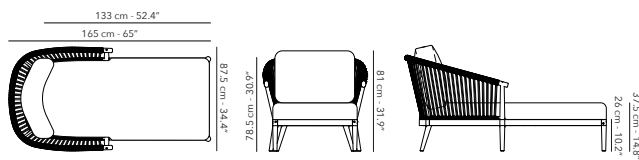
Other fabrics upon request.
Find an overview on p. 254.
Protection cover available.





COFFEE TABLE 120 x 60 cm

	FULEGLT09 frame		W64 sable teak	
--	---------------------------	--	-----------------------	--

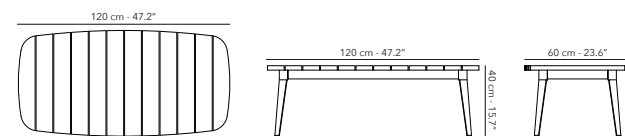
14.2 kg
31.3 lbs



SIDE TABLE 50 x 35 cm

	FULEGST07 frame		W64 sable teak	
---	---------------------------	---	-----------------------	--

4.4 kg
9.7 lbs

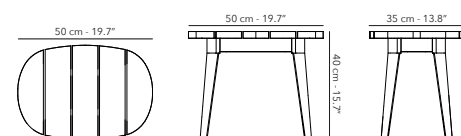





Aluminium powder coated frame.
 Table top is made of raw teak with a thickness of 50 mm.
 No piece is the same, each table top is unique.
 Teak care kit available.

NATURE

UPDATED

BENCH 280 cm



	FUNATBE46S frame		A32 black
	FUNATTOP46B seat		W62 teak

 94.1 kg
207.5 lbs

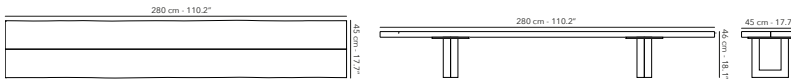
It is not possible to combine a Nature bench with a low dining table.



BENCH 350 cm

	FUNATBE46S frame		A32 black
	FUNATTOP48B seat		W62 teak

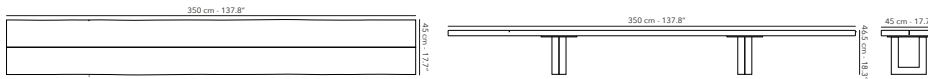

 125.5 kg
276.7 lbs

It is not possible to combine a Nature bench with a low dining table.



BENCH 400 cm

NEW

	FUNATBE46S frame		A32 black
	FUNATTOP51B seat		W62 teak

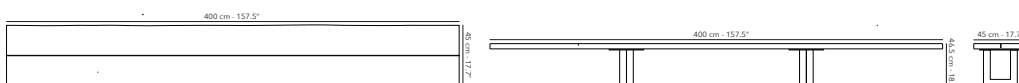

 139.5 kg
307.5 lbs

It is not possible to combine a Nature bench with a low dining table.



NATURE

DINING TABLE 280 x 120 cm



	FUNATDT46S frame		A32 black
	FUNATTOP46 table top		W62 teak

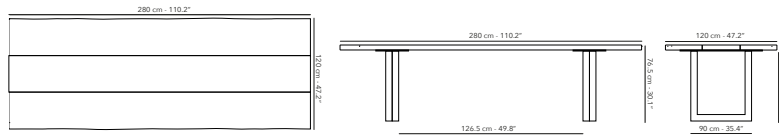

171.8 kg
378.8 lbs



DINING TABLE 350 x 120 cm



	FUNATDT46S frame		A32 black
	FUNATTOP48 table top		W62 teak

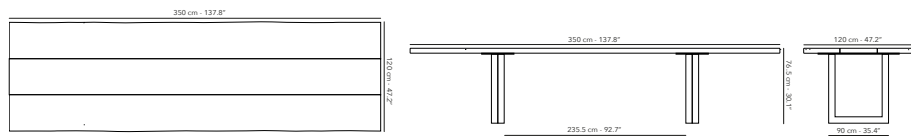

218 kg
480.5 lbs



DINING TABLE 400 x 120 cm

	FUNATDT46S frame		A32 black
	FUNATTOP51 table top		W62 teak



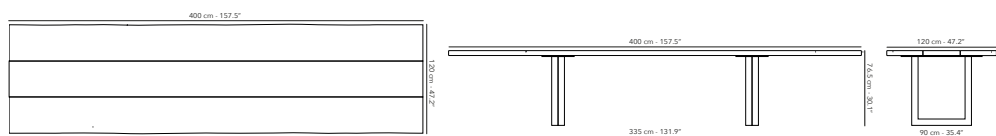

229.3 kg
505.2 lbs



NATURE

LOW DINING TABLE 280 x 120 cm

	FUNATLDT46S frame		A32 black
	FUNATTOP46 table top		W62 teak



LOW DINING

 169 kg
372.5 lbs

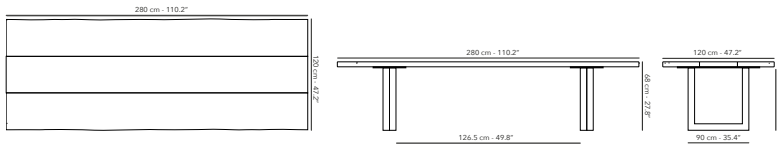
It is not possible to combine a Nature bench with a low dining table.



LOW DINING TABLE 350 x 120 cm

	FUNATLDT46S frame		A32 black
	FUNATTOP48 table top		W62 teak



LOW DINING

 215.4 kg
474.9 lbs

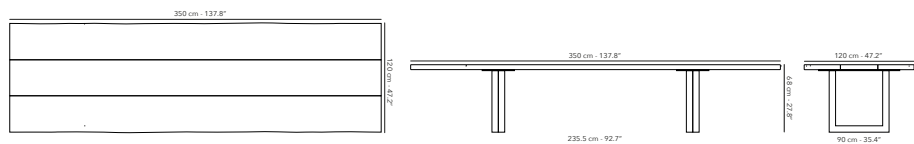
It is not possible to combine a Nature bench with a low dining table.



LOW DINING TABLE 400 x 120 cm

	FUNATLDT46S frame		A32 black
	FUNATTOP51 table top		W62 teak

NEW - LOW DINING

 226.5 kg
500 lbs

It is not possible to combine a Nature bench with a low dining table.

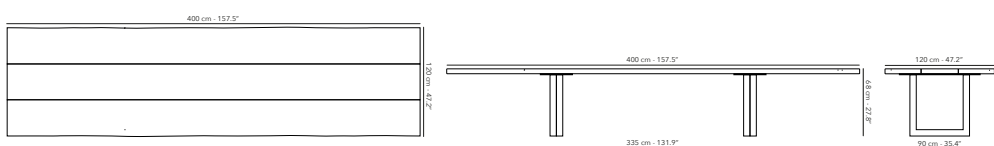

TECCA

Solid teak frame.
Cushions are weatherproof and colour resistant.
Teak care kit available.

DINING TABLE 160 x 80 cm

	<p>FUTECDT41 frame</p>		<p>W62 teak</p>
---	----------------------------	---	-----------------



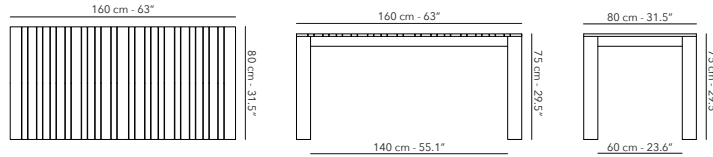

39.5 kg
87 lbs

Ideal with **Tecca bench 130 x 38 cm**.
Fits under the long sides of the table.



DINING TABLE 280 x 100 cm

	<p>FUTECDT46 frame</p>		<p>W62 teak</p>
--	----------------------------	--	-----------------



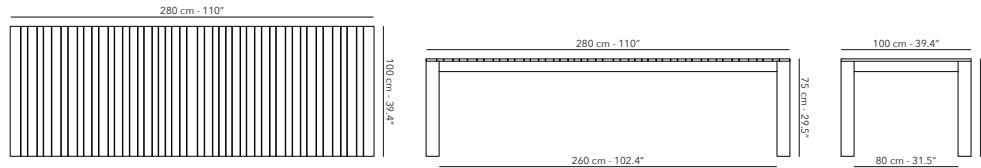

70.4 kg
155.2 lbs

Ideal with **Tecca bench 130 x 38 cm**.
Place two next to each other on
the long sides of the table.



DINING TABLE 350 x 100 cm

	<p>FUTECDT48 frame</p>		<p>W62 teak</p>
---	----------------------------	---	-----------------



84.6 kg
186.5 lbs

Ideal with **Tecca bench 320 x 38 cm**.
Fits under the long sides of the table.

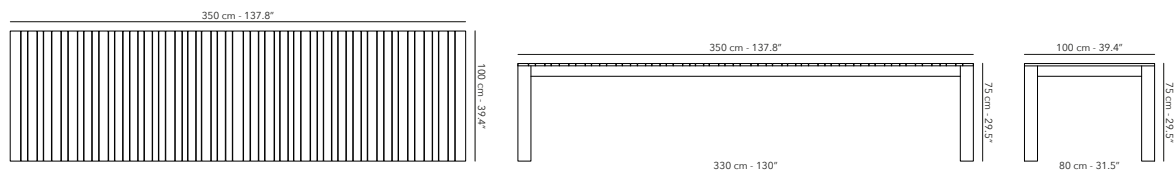

TECCA

DINING TABLE 160 x 160 cm



FUTECDT61
frame



W62 teak



59.4 kg
131 lbs

Ideal with **Tecca bench 130 x 38 cm.**
Fits either side of the table.

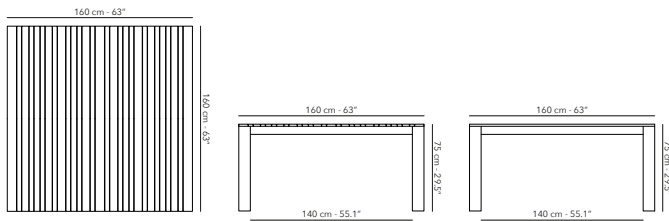

BENCH 130 x 38 cm



FUTECBE41
frame



W62 teak



19 kg
42 lbs

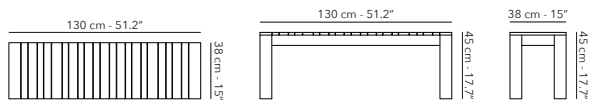

BENCH 320 x 38 cm



FUTECBE48
frame



W62 teak



38.1 kg
84 lbs

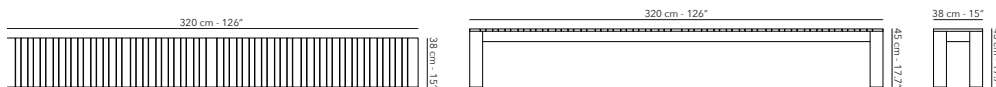

TECCA

SUNLOUNGER

	QUICK DRY COMFORT	FUTECSL05 frame	 W62 teak	38 kg 83.8 lbs
		CUTECSL05 cushions	 C007 beige cat. C 	
		CUTECSL05-CF cushions	 C205 ebony cat. C   C007 beige cat. C  C205 ebony cat. C	

Other fabrics upon request.
 Find an overview on p. 254.
 Protection cover available.

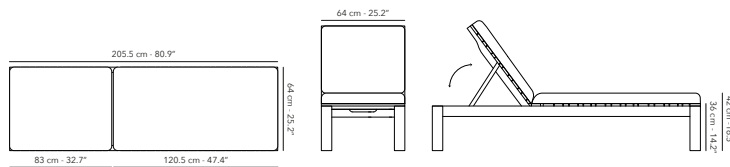









Tables or armrests can be used on both sides, connectors included.
 Table top is made of solid teak or ceramic 12 mm.
 Powder coated aluminium frame.

MAUROO

UPDATED

LOUNGE CHAIR 1S







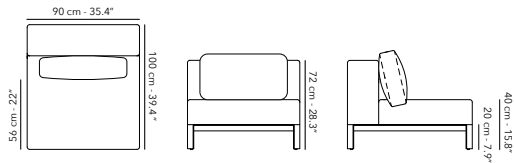

	QUICK DRY	FUMAUMS02 frame		A01 white	
				A31 charcoal	
	COMFORT	CUMAUMS02 cushions			C006 vanilla cat. C 
					C202 smoke grey cat. 
	COMFORT	CUMAUMS02-CF cushions			C006 vanilla cat. C
					C202 smoke grey cat. C

    13.5 kg
29.8 lbs

Other fabrics upon request.
 Find an overview on p. 254.
 Protection cover available.



SOFA 2S

	QUICK DRY	FUMAUDS02M frame		A01 white	
				A31 charcoal	
	COMFORT	CUMAUDS02M cushions			C006 vanilla cat. C 
					C202 smoke grey cat. 
	COMFORT	CUMAUDS02M-CF cushions			C006 vanilla cat. C
					C202 smoke grey cat. C





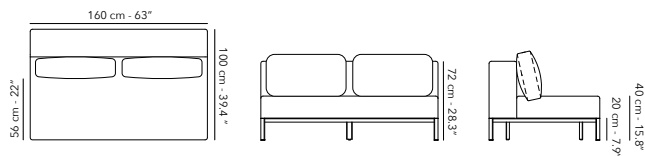







    23 kg
50.7 lbs





Other fabrics upon request.
 Find an overview on p. 254.
 Protection cover available.



MAUROO

LONG SOFA WITH TABLE







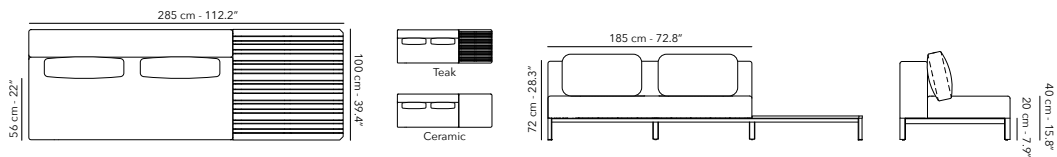





	FUMAUDS02LRF frame	 A01 white
		 A31 charcoal
	FUMAUTOP07 table top	 W62 teak
		 K02 bianco
		 K14 taupegrey
		 K31 charcoal
	QUICK DRY CUMAUDS02LR cushions	 C006 vanilla cat. C 
		 C202 smoke grey cat. C 
	COMFORT CUMAUDS02LR-CF cushions	 C006 vanilla cat. C
		 C202 smoke grey cat. C









W62
 25 kg
 55.1 lbs

Other fabrics upon request.
Find an overview on p. 254.
Protection cover available.



LONG SOFA WITH TABLE & ARM

	FUMAUDS02LRF FUMAUARM01 frame	 A01 white
		 A31 charcoal
	FUMAUTOP07 table top	 W62 teak
		 K02 bianco
		 K14 taupegrey
		 K31 charcoal
	QUICK DRY CUMAUDS02LRA cushions	 C006 vanilla cat. C 
		 C202 smoke grey cat. C 
	COMFORT CUMAUDS02LRA-CF cushions	 C006 vanilla cat. C
		 C202 smoke grey cat. C



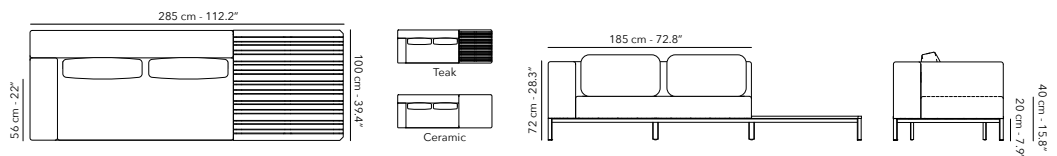

W62
 27 kg
 59.5 lbs

Other fabrics upon request.
Find an overview on p. 254.
Protection cover available.



MAUROO

CHAISE LONGUE



FUMAUCLO2LRF
frame



A01 white



A31 charcoal



W62 teak



K02 bianco



K14 taupegrey



K31 charcoal

FUMAUTOP09
table top

QUICK DRY

CUMAUDS02LR
cushions



C006 vanilla cat. C



C202 smoke grey cat. C



COMFORT

CUMAUDS02LR-CF
cushions



C006 vanilla cat. C



C202 smoke grey cat. C







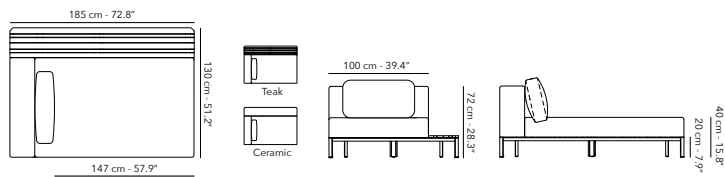

W62
23 kg
50.7 lbs

Other fabrics upon request.
Find an overview on p. 254.
Protection cover available.



MAUROO

COFFEE TABLE 120 x 80 cm





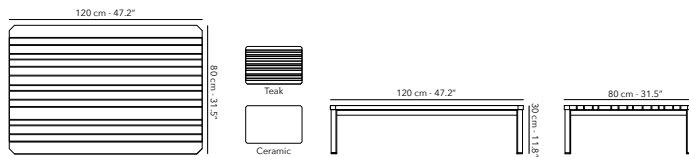

	FUMAULT03F frame	 A01 white
		 A31 charcoal
	FUMAUTOP08 table top	 W62 teak
		 K02 bianco
		 K14 taupegrey
		 K31 charcoal

 **W62**
 21.5 kg
 47.4 lbs



MODULAR TABLE





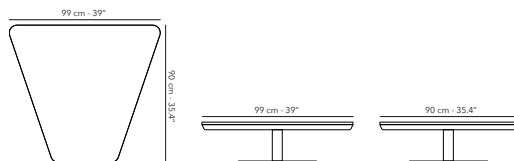







NEW

	FUMAUMT01 frame	 A01 white
		 A31 charcoal
	FUMAUTOP10 table top	 K02 bianco
		 K14 taupegrey
		 K31 charcoal



CONCEPT 1

LEFT / RIGHT

	frame	1x FUMAUMT01 1x FUMAUDS02M 1x FUMAULT03F 1x FUMAUDS02LRF	 A01 white
			 A31 charcoal
	table top	1x FUMAUMTOP10 1x FUMAUTOP07 1x FUMAUTOP08	 W62 teak
			 K02 bianco
			 K14 taupegrey
			 K31 charcoal
COMFORT QUICK DRY	cushions	1x CUMAUDS02LR 1x CUMAUDS02M	 C006 vanilla cat. C 
			 C202 smoke grey cat. G 
COMFORT	cushions	1x CUMAUDS02LR-CF 1x CUMAUDS02M-CF	 C006 vanilla cat. C
			 C202 smoke grey cat. C





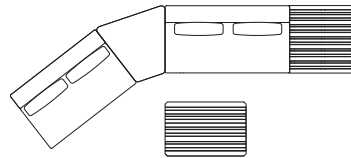
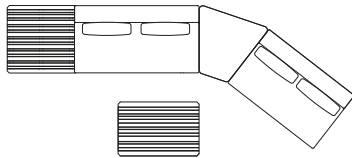









Other fabrics upon request.
Find an overview on p. 254.
Protection cover available per module.



CONCEPT 2

LEFT / RIGHT

	frame	1x FUMAUMT01 2x FUMAUDS02M 1x FUMAULT03F 1x FUMAUDS02LRF 1x FUMAARM01	 A01 white
			 A31 charcoal
	table top	1x FUMAUMTOP10 1x FUMAUTOP07 1x FUMAUTOP08	 W62 teak
			 K02 bianco
			 K14 taupegrey
			 K31 charcoal
COMFORT QUICK DRY	cushions	1x CUMAUDS02LRA 2x CUMAUDS02M	 C006 vanilla cat. C 
			 C202 smoke grey cat. G 
COMFORT	cushions	1x CUMAUDS02LRA-CF 2x CUMAUDS02M-CF	 C006 vanilla cat. C
			 C202 smoke grey cat. C



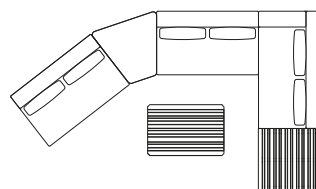
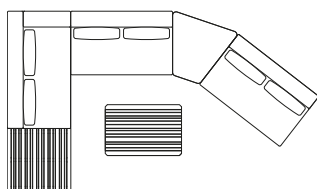

Other fabrics upon request.
Find an overview on p. 254.
Protection cover available per module.



FLEXX

Solid teak frame with anthracite rope 25 mm.
Cushions are weatherproof and colour resistant.
Teak care kit available.

DINING ARMCHAIR



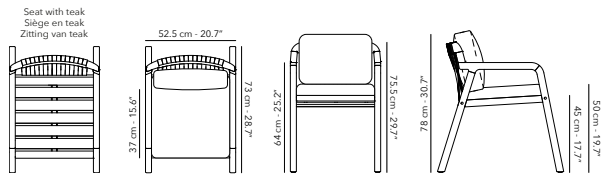

	FUFLE-AC01 frame	 	W62R30 teak & anthracite strap
	CUFLEAC01 cushions		C005 marble cat. C

 14.5 kg
32 lbs

Other fabrics upon request.
Find an overview on p. 254.
Protection cover available.



BAR CHAIR



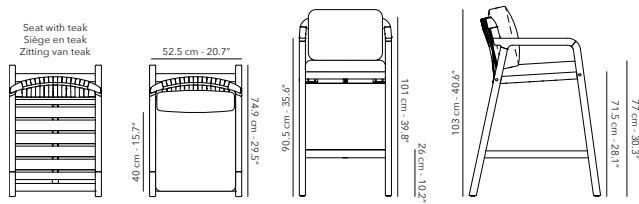

	FUFLE-BC01 frame	 	W62R30 teak & anthracite strap
	CUFLEAC01 cushions		C005 marble cat. C

 19.5 kg
43 lbs

Other fabrics upon request.
Find an overview on p. 254.
Protection cover available.



COUNTER CHAIR

	FUFLE-CC01 frame	 	W62R30 teak & anthracite strap
	CUFLEAC01 cushions		C005 marble cat. C

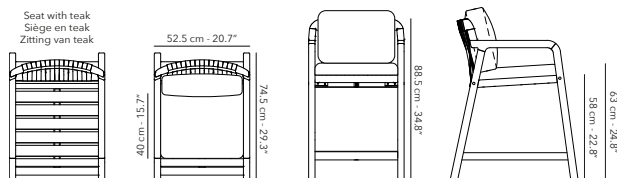

 17.5 kg
38.6 lbs

Other fabrics upon request.
Find an overview on p. 254.
Protection cover available.



FLEXX

DINING TABLE 240 x 100 cm



	FUFLE-DT44 frame		W62 teak
---	----------------------------	---	-----------------

 51.8 kg
114.2 lbs

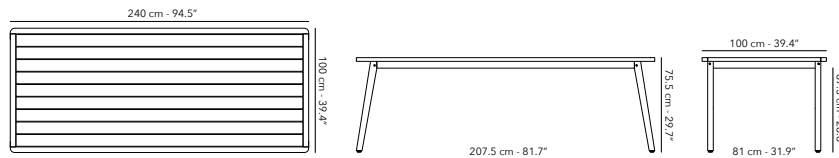
Protection cover available.



DINING TABLE 300 x 100 cm



	FUFLE-DT47 frame		W62 teak
--	----------------------------	---	-----------------

 66.3 kg
146.2 lbs

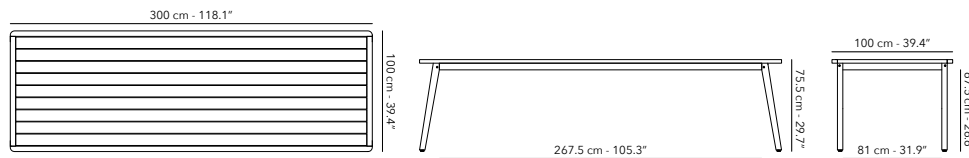
Protection cover available.



BISTRO TABLE 80 x 80 cm

	FUFLE-BI23 frame		W62 teak
---	----------------------------	---	-----------------

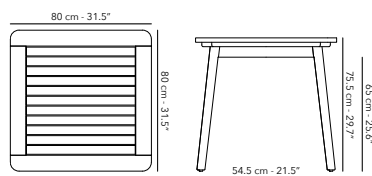

 16 kg
35.3 lbs

Protection cover available.



FLEXX

BAR TABLE 170 x 80 cm



	FUFLE-BT01 frame		W62 teak
---	----------------------------	---	-----------------

 24 kg
52.9 lbs

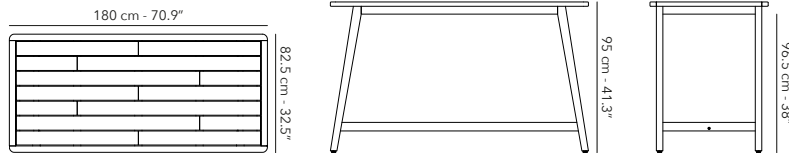
Protection cover available.



COUNTER TABLE 170 x 80 cm





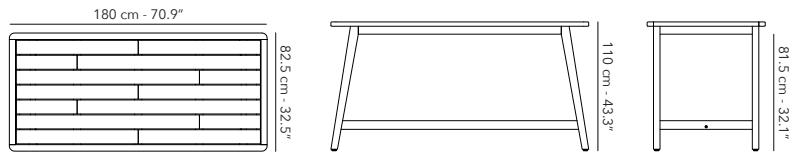

	FUFLE-CT01 frame		W62 teak
--	----------------------------	--	-----------------

 22 kg
48.5 lbs

Protection cover available.





LOUNGE CHAIR 1S

		FUFLE-1S01 frame	 W62R30 teak & anthracite strap	 20.5 kg 45.2 lbs
	Q. DRY	CUFLE1S01 cushions	 C005 marble cat. D 	
	COMF.	CUFLE1S01-CF cushions	 C005 marble cat. D	

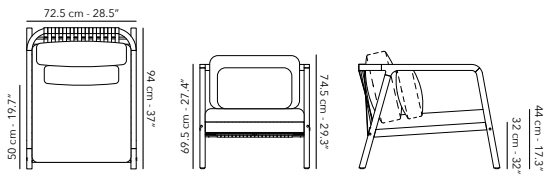
Other fabrics upon request.
Find an overview on p. 254.
Protection cover available.







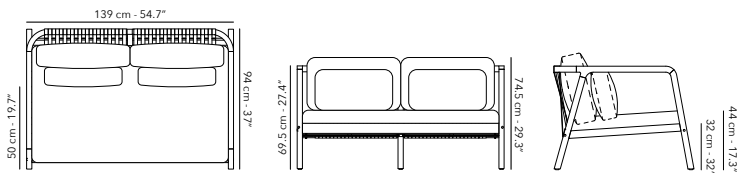

SOFA 2S

		FUFLE-2S01 frame	 W62R30 teak & anthracite strap	 32.5 kg 71.7 lbs
	Q. DRY	CUFLE2S01 cushions	 C005 marble cat. D 	
	COMF.	CUFLE2S01-CF cushions	 C005 marble cat. D	

Other fabrics upon request.
Find an overview on p. 254.
Protection cover available.



SOFA 3S

		FUFLE-3S01 frame	 W62R30 teak & anthracite strap	 45 kg 99.2 lbs
	Q. DRY	CUFLE3S01 cushions	 C005 marble cat. D 	
	COMF.	CUFLE3S01-CF cushions	 C005 marble cat. D	

Other fabrics upon request.
Find an overview on p. 254.
Protection cover available.

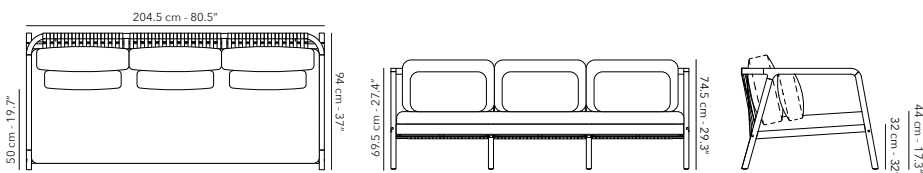

FLEXX

COFFEE TABLE 120 x 80 cm



FUFLE-LT01
frame



W62 teak



15.1 kg
33.3 lbs

Protection cover available.

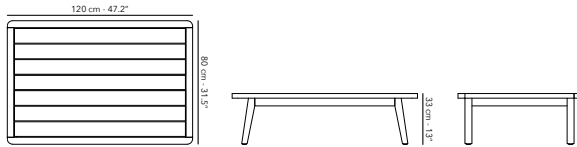

COFFEE TABLE 120 x 120 cm



FUFLE-LT02
frame



W62 teak



21.2 kg
46.7 lbs

Protection cover available.

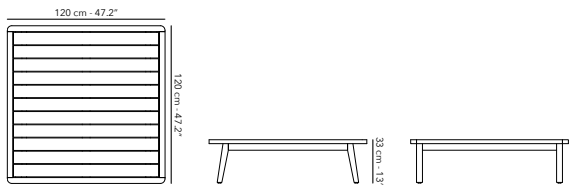

SIDE TABLE 45 x 45 cm



FUFLE-ST01
frame







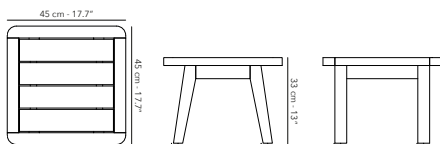

W62 teak



6 kg
13.2 lbs



SUNLOUNGER

		 W62R30 teak & anthracite strap
	Q. DRY	 FUFLE-SL01 frame
	COMF.	 CUFLES01 cushions
		 C005 marble cat. D
		 C005 marble cat. D







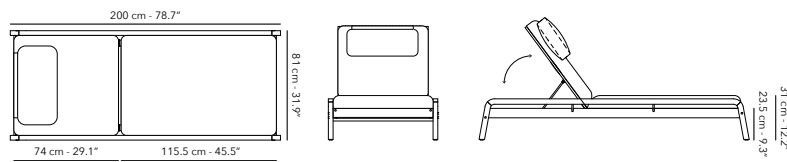

28 kg
61.7 lbs

Other fabrics upon request.
Find an overview on p. 254.
Protection cover available.



DAYBED

		 W62R30 teak & anthracite strap
	Q. DRY	 FUFLEDB01 frame
	COMF.	 CUFLEDB01 cushions
		 C005 marble cat. D
		 C005 marble cat. D



44 kg
97 lbs



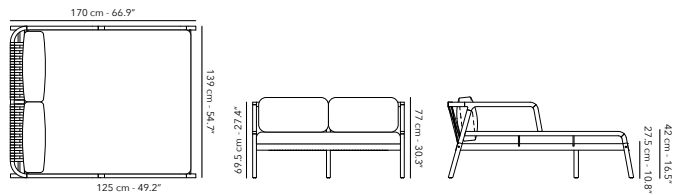

Other fabrics upon request.
Find an overview on p. 254.
Protection cover available.



KUDOS

Aluminium powder coated frame with steel base.
Chairs in full aluminium.

BISTRO CHAIR



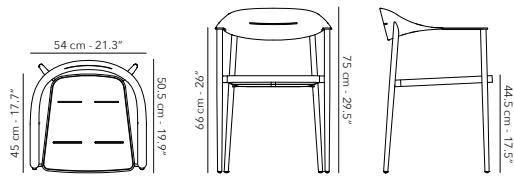

	FUKUDBIA01 frame	 A01 white
		 A03 linen
		 A32 black
		 A69 lime

 5.1 kg
11.2 lbs

Sold per 2 pieces.
2 pieces in 1 colour per box.





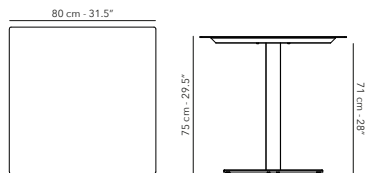

BISTRO TABLE SQUARE 80 x 80 cm

	FUKUDBIT43 frame	 A01 white
		 A03 linen
		 A32 black



 26 kg
57.3 lbs



BISTRO TABLE ROUND ø 75 cm

	FUKUDBIT03 frame	 A01 white
		 A03 linen
		 A32 black

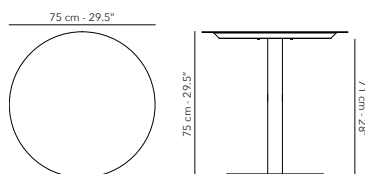



 17.2 kg
40 lbs



Aluminium powder coated frame with steel base.
Chairs in full aluminium or with upholstered textile.



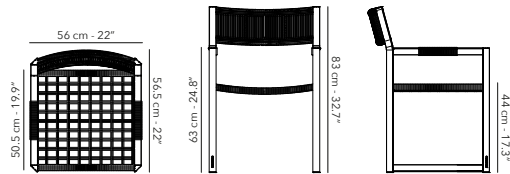

MANTRA

BISTRO ARMCHAIR

	FUMANBIA02 frame		A01R02 white & silver	6 kg 13.2 lbs
			A30R30 anthracite	





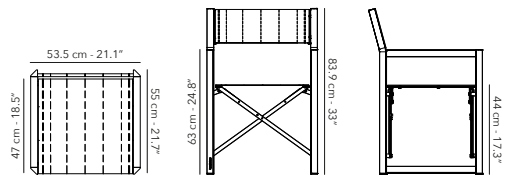

DIRECTOR CHAIR

	FUMANDC01 frame		A01T02 white & silver	 6 kg 13.2 lbs
			A30T30 anthracite	



MANTRA

BISTRO TABLE SQUARE 75 x 75 cm





	FUMANBIT22S frame	 A01 white
		 A30 anthracite
	FUMANBIT22T table top	 A01 white
		 A30 anthracite

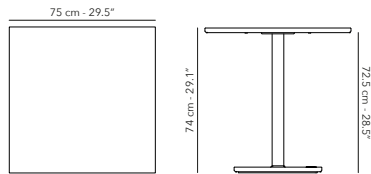

28.5 kg
62.8 lbs



BISTRO TABLE ROUND ø 80 cm





	FUMANBIT03S frame	 A01 white
		 A30 anthracite
	FUMANBIT03T table top	 A01 white
		 A30 anthracite

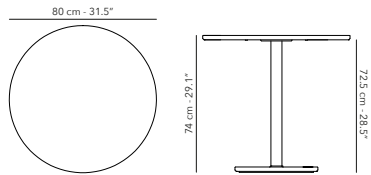

24.7 kg
54.4 lbs



SUNLOUNGER

	FUMANSL04 frame	 A01T02 white & silver
		 A30T30 anthracite
		 A01T02 white & silver
		 A30T30 anthracite



11 kg
24.2 lbs

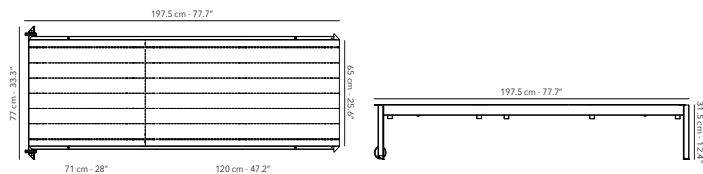

BYBLOS

BEACH CHAIR



FUBYBSC01



W62T30
teak & anthracite

6 kg
13.2 lbs

The headrest is adjustable
and can be removed.

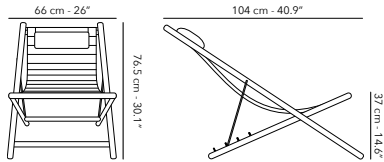

STAND



FUBYBSD01



W62 teak

1.5 kg
3.3 lbs

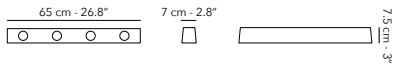

BOLSA

UPDATED

Filling of mixed fibre, polyester fibre & EPS beads.
 Bottom is made of black textilene, water-repellent.
 100% made in Belgium.

LOUNGE CHAIR 1S 125 cm

	FUBOL1S	Cat. A
		Cat. B
		Cat. C
		Cat. D
		Cat. E

14.5 kg
 31.9 lbs

Packed in a carton box.
 Protection cover available.

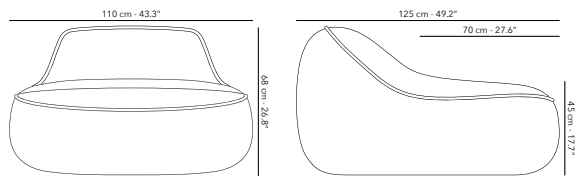

CHAISE LONGUE 150 cm

	FUBOLCL150	Cat. A
		Cat. B
		Cat. C
		Cat. D
		Cat. E

20.5 kg
 45.2 lbs

Packed in a carton box.
 Protection cover available.

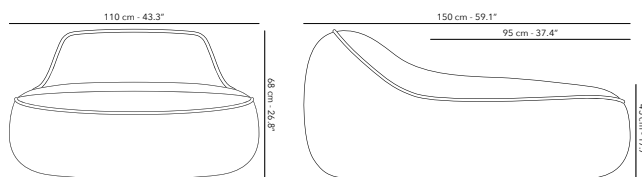

CHAISE LONGUE 170 cm

	FUBOLCL170	Cat. A
		Cat. B
		Cat. C
		Cat. D
		Cat. E

Packed in a polybag.
 Protection cover available.

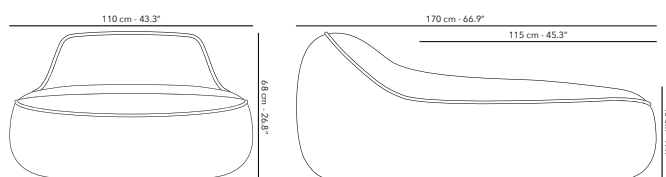

Powder coated aluminium frame with hand woven rope 3.5 mm.
Cushions are weatherproof and colour resistant.

MANI
NEW

DINING ARMCHAIR

NEW

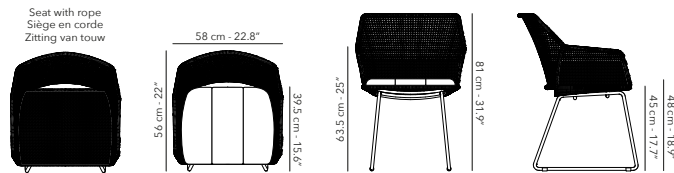

	FUMANAC12 frame		A04R04 almond & almond
	CUMAN(L)AC01 cushions		C015 brûlé cat. D

 8.4 kg
18.5 lbs



LOUNGE CHAIR 1S

NEW

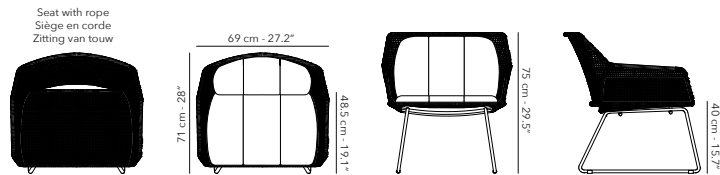

	FUMAN1S frame		A04R04 almond & almond
	CUMAN1S01 cushions		C015 brûlé cat. D

 18.4 kg
41 lbs



FOOTSTOOL

NEW

	FUMANFS frame		A04R04 almond & almond
---	------------------	---	---------------------------



 4.1 kg
9 lbs



DINING CHAIRS

NEW

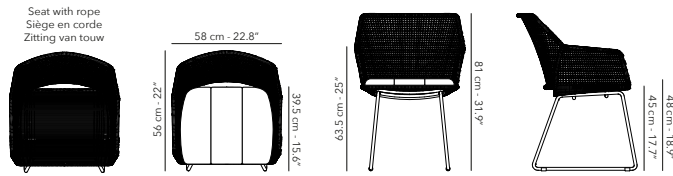

LEWIS DINING ARMCHAIR

	FULEWAC10 frame	 A32R32 black & black	7.5 kg 16.5 lbs
	CULEW(L)AC01 cushions	 C006 vanilla cat. C	



LEWIS LOW DINING ARMCHAIR



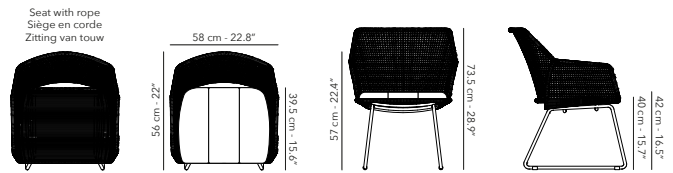

LOW DINING

	FULEWLAC01 frame	 A32R32 black & black	6.6 kg 14.6 lbs
	CULEW(L)AC01 cushions	 C006 vanilla cat. C	



DINING CHAIRS

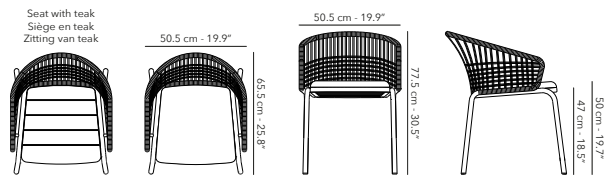

YUNA DINING ARMCHAIR

	FUYUNAC07 frame	 A03R03 linen & linen	7.2 kg 16 lbs
	CUYUNAC07 cushions	 A31R31 charcoal & charcoal  C007 beige cat. C  C205 ebony cat. C	



DUNE DINING ARMCHAIR

NEW



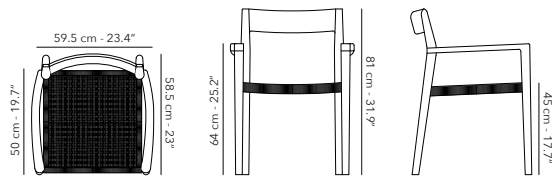



	FUDUNAC14 frame	 W62R03 teak & linen	18.6 kg 41 lbs
--	--------------------	--	-------------------



NESTING TABLES

UPDATED

NESTING SIDE TABLE ø 40 cm







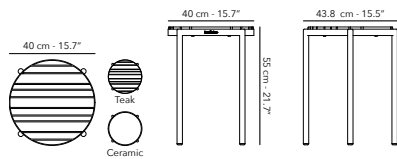

	FUVOLST02S frame	 A01 white
		 A31 charcoal
	FUVOLTOP00 table top	 W62 teak
		 K02 bianco
		 K14 taupegrey
		 K31 charcoal



K01 - K14 - K31 **W62**
 5.6 kg 3.5 kg
 12.3 lbs 7.7 lbs



NESTING SIDE TABLE ø 50 cm





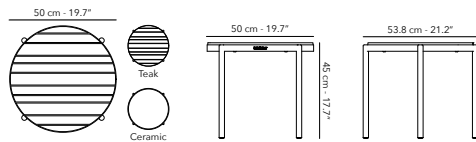

	FUVOLST03S frame	 A01 white
		 A14 lava
	FUVOLTOP01 table top	 A31 charcoal
		 W62 teak
		 K02 bianco
		 K14 taupegrey
 K31 charcoal		



K01 - K14 - K31 **W62**
 7.6 kg 5 kg
 16.8 lbs 11 lbs



NESTING COFFEE TABLE ø 60 cm

	FUVOLST06S frame	 A01 white
		 A31 charcoal
	FUVOLTOP02 table top	 W62 teak
		 K02 bianco
		 K14 taupegrey
		 K31 charcoal



K01 - K14 - K31 **W62**
 10.5 kg 6 kg
 23.1 lbs 13.2 lbs

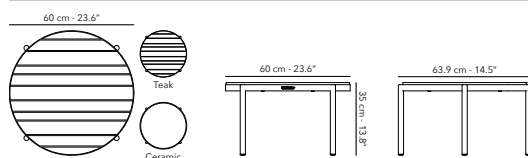

NESTING TABLES

NESTING COFFEE TABLE ø 75 cm



FUVOLST04S
frame

FUVOLTOP03
table top

	A01 white
	A14 lava
	A31 charcoal
	W62 teak
	K02 bianco
	K14 taupegrey
	K31 charcoal



K01 - K14 - K31	W62
14.8 kg	8 kg
32.6 lbs	17.6 lbs

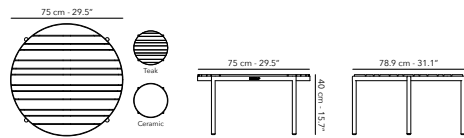

NESTING COFFEE TABLE ø 90 cm



FUVOLST05S
frame

FUVOLTOP04
table top

	A01 white
	A14 lava
	A31 charcoal
	W62 teak
	K02 bianco
	K14 taupegrey
	K31 charcoal



K01 - K14 - K31	W62
20.5 kg	10 kg
45.2 lbs	22 lbs

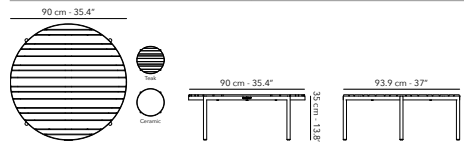

NESTING TABLES

TARO COFFEE TABLE ROUND \varnothing 90 cm

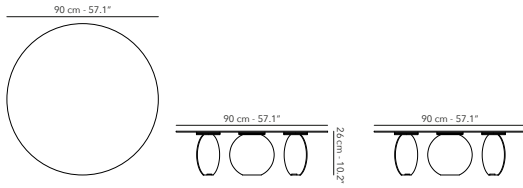

NEW

	<p>FUTARLT13 frame</p>		<p>A03 linen</p>
---	----------------------------	---	------------------



TARO COFFEE TABLE ORGANIC 145 x 100 cm

NEW

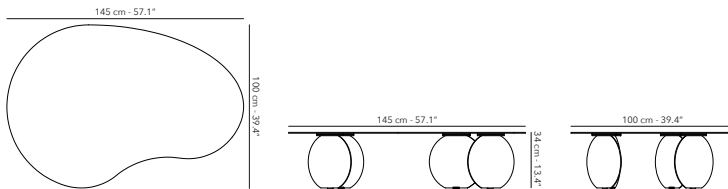

	<p>FUTARLT14 frame</p>		<p>A03 linen</p>
--	----------------------------	---	------------------



NESTING TABLES

KOBE SIDE TABLE ø 40 cm

NEW

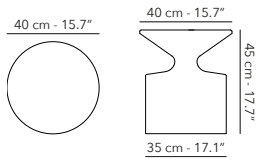

	<p>FUKOBST11 Kobe side table small</p>		<p>W62 teak</p>
---	---	---	------------------------

19.1 kg
42.1 lbs



KOBE SIDE TABLE ø 50 cm



NEW

	<p>FUKOBST12 Kobe side table large</p>		<p>W62 teak</p>
--	---	--	------------------------

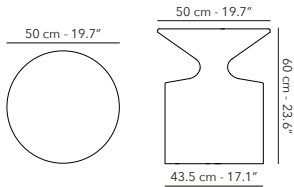
38.3 kg
84.4 lbs



DUNCAN

	<p>DEDECDUN.01 teak block</p>		<p>W62 teak</p>
---	--	---	------------------------

27.4 kg
60.4 lbs

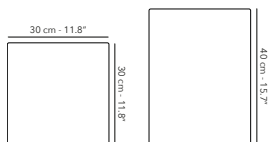

POTTERY













UPDATED

Each pot is made with natural materials, combined with FRP.
A robust, yet lightweight pot, UV and frost resistant.













TERRA CLASSIC

	DEPOTTERC48.L 6 kg, 13.2 lbs ø 48 x 57 cm, 19 x 22.5"		P03 sabbia
			P11 macchiato
			P32 nero
	DEPOTTERC60.M 9 kg, 19.8 lbs ø 60 x 72 cm, 23.6 x 28.3"		P03 sabbia
			P11 macchiato
			P32 nero
	DEPOTTERC150.H 70 kg, 154.3 lbs ø 150 x 180 cm, 59 x 71"		P11 macchiato

TERRA BALLOON





	DEPOTTERB55.L 5 kg, 11 lbs ø 55 x 35 cm, 22 x 14"		P03 sabbia
			P11 macchiato
			P32 nero
	DEPOTTERB55.M 5.5 kg, 12.1 lbs ø 55 x 45 cm, 22 x 18"		P03 sabbia
			P11 macchiato
			P32 nero
	DEPOTTERB55.H 6 kg, 13.2 lbs ø 55 x 56 cm, 22 x 22"		P03 sabbia
			P11 macchiato
			P32 nero

TERRA CERCHIO

	DEPOTTERB-SET1: 31 kg, 68.3 lbs DEPOTTERB91.H DEPOTTERB112.H		P03 sabbia
			P11 macchiato
			P32 nero
	DEPOTTERB91.H 12 kg, 26.5 lbs ø 91 x 56 cm, 36 x 22"		P03 sabbia
			P11 macchiato
			P32 nero
	DEPOTTERB112.H 19 kg, 41.9 lbs ø 112 x 67 cm, 44 x 26"		P03 sabbia
			P11 macchiato
			P32 nero

POTTERY









TERRA DÔME SET

	DEPOTTERD-SET1 32 kg, 70.5 lbs ø 45 x 45 cm, 17.7 x 17.7" ø 61 x 61 cm, 24 x 24" ø 83 x 82 cm, 32.6 x 32.3"		P03 sabbia
			P11 macchiato
			P32 nero



TERRA ALTO

	DEPOTERR45.M ø 45 x 112 cm, 18 x 44"		P03 sabbia
			P11 macchiato
			P32 nero
	DEPOTERR55.H ø 55 x 137 cm, 22 x 54"		P03 sabbia
			P11 macchiato
			P32 nero



CUMINO ALBERO

	DEPOTCUM-SET1: DEPOTCUM52.L DEPOTCUM68.M DEPOTCUM88.H		P18 ruggine
	DEPOTCUM52.L ø 52 x 60 cm, 20 x 24"		P18 ruggine
	DEPOTCUM68.M ø 68 x 80 cm, 27 x 31"		P18 ruggine
	DEPOTCUM88.H ø 88 x 102 cm, 35 x 40"		P18 ruggine

CUMINO FIORE



	DEPOTCUM-SET2 ø 55 x 46 cm, 21.6 x 18" ø 65 x 54 cm, 25.5 x 21.2" ø 80 x 66 cm, 31.5 x 26"		P18 ruggine
---	--	---	-------------

CUMINO FUNGO

	DEPOTCUM114.L ø 114 x 54 cm, 56,7 x 21"		P01 panna
---	---	---	-----------



POTTERY

CUMINO CALICE

	<p>DEPOTCUMB120.H ø 120 x 130 cm, 47 x 51"</p>		<p>P01 panna</p>
---	--	---	------------------

CUMINO CONICO

NEW

	<p>DEPOTCUM-SET3: DEPOTCUM46.L 4 kg, 8.8 lbs ø 46 x 46 cm, 18.1 x 18.1"</p>		<p>P01 panna</p>
	<p>DEPOTCUM61.M 9 kg, 19.8 lbs ø 61 x 61,5 cm, 24 x 24.2"</p> <p>DEPOTCUM84.H 15 kg, 33.1 lbs ø 84 x 82 cm, 33.1 x 32.3"</p>		<p>P18 ruggine</p>

CARTELLO

	<p>DEPOTCAR75.L ø 75 x 35 cm, 30 x 14"</p>		<p>P31 marone</p>
	<p>DEPOTCAR75.H ø 75 x 68 cm, 30 x 27"</p>		<p>P31 marone</p>



CURVO

	<p>DEPOTCUR-SET1: DEPOTCUR32.L DEPOTCUR45.M DEPOTCUR55.H</p>		<p>P30 caffè</p>
	<p>DEPOTCUR32.L ø 32 x 60 cm, 13 x 24"</p>		<p>P30 caffè</p>
	<p>DEPOTCUR45.M ø 45 x 80 cm, 18 x 31"</p>		<p>P30 caffè</p>
	<p>DEPOTCUR55.H ø 55 x 90 cm, 22 x 35"</p>		<p>P30 caffè</p>

POTTERY



ANTICO ANFORA

NEW

	DEPOTANT55.L 5.5 kg, 12.1 lbs ø 55 x 55 cm, 21.7 x 21.7"		P07 pistachio
			P12 bronzo







ANTICO VASO

NEW

	DEPOTANT55.H 14 kg, 30.9 lbs ø 55 x 112 cm, 21.7 x 44"		P07 pistachio
			P12 bronzo

TUGU

NEW

	DEPOTTUG45.S 3.8 kg, 8.4 lbs ø 45 x 35 cm, 17 x 14"		F16 cottage
	DEPOTTUG65.M 7.3 kg, 16.1 lbs ø 65 x 50 cm, 26 x 20"		F16 cottage
	DEPOTTUG85.L 11.5 kg, 25.4 lbs ø 85 x 70 cm, 33 x 28"		F16 cottage

RUGS

WILSON



DERUGWIL200X300
200 x 300 cm, 79 x 118"



D78 oyster



D79 greige

DERUGWIL250X350
250 x 350 cm, 98 x 138"



D78 oyster



D79 greige

DERUGWIL280X390
280 x 390 cm, 110 x 154"



D78 oyster



D79 greige

Polyester and high-quality Decolan yarn.
Made in Belgium.

COCO

NEW



DERUGCOC300XR
ø 300 cm, 118"



D72 camel

DERUGCOC300X400
300 x 400 cm, 118 x 157"



D72 camel

DERUGCOC400X600
400 x 600 cm, 157 x 236"



D72 camel

100% hand woven, recycled PET.

IONA

NEW



DERUGION300XR
ø 300 cm, 118"



D05 seal

DERUGION300X400
300 x 400 cm, 118 x 157"



D05 seal

DERUGION400X500
400 x 500 cm, 157 x 197"



D05 seal

PVC coated polyester.

YARA

NEW



DERUGYAR300XR
ø 300 cm, 118"



D71 biscuit

DERUGYAR250X350
250 x 350 cm, 98 x 138"



D71 biscuit

DERUGYAR300X400
300 x 400 cm, 118 x 158"



D71 biscuit

PVC coated polyester.

POUFS

BAY



DEPOUBAY.RS

small
ø 50 x 40 cm, 19 x 16"

DEPOUBAY.RM

medium
ø 50 x 50 cm, 19 x 19"

DEPOUBAY.RL

large
ø 80 x 40 cm, 32 x 16"

Find an overview of the fabrics on p. 254.

COCO

NEW



DEPOUCOC.RS

round small
ø 50 x 40 cm, 19 x 16"



D72 camel

DEPOUCOC.RM

round medium
ø 50 x 50 cm, 19 x 19"



D72 camel

DEPOUCOC.RL

round large
ø 80 x 40 cm, 32 x 16"



D72 camel

DEPOUCOC.SS

square small
50 x 40 cm, 20 x 16"



D72 camel

DEPOUCOC.SL

square large
100 x 40 cm, 39 x 16"













D72 camel

100% hand woven, recycled PET.

LIGHTING

SOLORE Solar Hybrid module incl.



	DELIGSOL.CS Cube small 25 x 25 cm, 10 x 10"	 F15 natural
	DELIGSOL.CM Cube medium 33,5 x 33,5 cm, 13 x 13"	 F15 natural
		 F17 taupe
	DELIGSOL.CL Cube large 43 x 43 cm, 17 x 17"	 F15 natural
		 F17 taupe
		DELIGSOL.SS Sphere small ø 30 x 24,5 cm, 12 x 10"
DELIGSOL.SM Sphere medium ø 38,5 x 33,5 cm, 15 x 13"		 F17 taupe
		 F15 natural
DELIGSOL.SL Sphere large ø 47,5 x 43 cm, 19 x 17"		 F17 taupe
		 F15 natural

Solar-powered LED lamp for warm outdoor light.
 Rechargeable battery with solar energy or USB.
 Can be placed on the ground or hung up.
 Supplied with rope and USB cable.
 Control the light with the application "SLS Control".
 Available in the App Store and Google Play.
 The Solore Solar Module is included.

Aluminium structure enclosed in HDPE fibre.

NOTO OVAL



NEW

	DELIGNOT.S oval small ø 39 x 48.5 cm, 15 x 19"	 A31R32 charcoal & black
	DELIGNOT.L oval large ø 48 x 60 cm, 19 x 24"	 A31R32 charcoal & black

Hand woven rope with solar lamp.



NOTO CONIC

NEW

	DELIGNOT.CS conic small	 A31R06 charcoal & natural
	DELIGNOT.CL conic large	 A31R06 charcoal & natural

Hand woven rope with solar lamp.



ARCO

	DELIGARC.S small ø 39 x 48.5 cm, 15 x 19"	 F18 straw
	DELIGARC.L large ø 48 x 60 cm, 19 x 24"	 F18 straw

Synthetic material with solar lamp.







ACCESSORIES

ANTIBES WINE

	DEDECANT-TUB.01 winetub ø 50 x 22.5 cm, 19.7 x 9"		W62 teak
	DEDECANT-COOL.01 winecooler ø30 x 30 cm, 12 x 12"		W62 teak

Teak with stainless steel parts.

ANTIBES

	SET: DECANANT.S DECANANT.M DECANANT.L		W62 teak
	DECANANT.S small 21 x 50 cm, 8 x 19.7"		W62 teak
	DECANANT.M medium 30 x 60 cm, 12 x 23.6"		W62 teak
	DECANANT.L large 32 x 90 cm, 13 x 35.4"		W62 teak

Teak with stainless steel parts.

PRANA

NEW

	DEBASPRA.S small ø 45 x 40 cm, 17.2 x 15.7"		D05 seal
	DEBASPRA.L large ø 65 x 58 cm, 25.6 x 22.8"		D05 seal

PVC coated polyester.

DECO CUSHIONS

DECO CUSHION



CUDECO40X40 40 x 40 cm

CUDECO50X30 50 x 30 cm

NEW

CUDECO50X50 50 x 50 cm

Find an overview of the fabrics on p. 254.

FAST STOCK DECO CUSHION 40 X 40 CM



C428
azul cat. D



C429
papaya cat. C

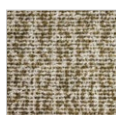

C434
turtle cat. C



C436
amaretto cat. C



C438
matcha cat. D



C439
ray cat. D



C440
scarlett cat. B



C441
wave cat. D



C442
peacock cat. D

ANA DECO CUSHION

NEW



CUANA40X40
40 x 40 cm
no filling

CUANA50X30
50 x 30 cm
no filling

CUDECO40X40
40 x 40 cm - filling only

CUDECO50X30
50 x 30 cm - filling only



C901 sakura



C902 thyme



C903 cobalt



C901 sakura



C902 thyme



C903 cobalt

FSP02 filling

FSP02 filling



FURNITURE OVERVIEW

DINING CHAIRS



Noa
Technical p. 182



Noa
Technical p. 182



Nero
Technical p. 188



Legna
Technical p. 197



Flexx
Technical p. 212



Kudos
Technical p. 218



Mantra
Technical p. 219



Mantra director
Technical p. 219



Mani
Technical p. 223



Lewis / Lewis low
Technical p. 224



Yuna
Technical p. 225



Dune
Technical p. 225

FURNITURE OVERVIEW

BENCHES



Nature
Technical p. 201



Tecca
Technical p. 205

BAR & COUNTER



Flexx bar
Technical p. 212



Flexx counter
Technical p. 212



Flexx bar
Technical p. 214



Flexx counter
Technical p. 214

FURNITURE OVERVIEW

DINING TABLES



Como
Technical p. 180



Como
Technical p. 180



Noa
Technical p. 183



Nero
Technical p. 188



Legna
Technical p. 198



Nature / Nature low
Technical p. 202



Tecca
Technical p. 204



Flexx
Technical p. 213

BISTRO TABLES



Flexx
Technical p. 213



Bistro Kudos
Technical p. 218



Bistro Kudos
Technical p. 218



Bistro Mantra
Technical p. 220



Bistro Mantra
Technical p. 220

FURNITURE OVERVIEW

LOUNGE CHAIRS



Noa
Technical p. 176



Noa
Technical p. 184



Nero
Technical p. 189



Scoop
Technical p. 191



Tugu
Technical p. 193



Legna
Technical p. 199



Mauroo
Technical p. 207



Flexx
Technical p. 215



Byblos
Technical p. 221



Bolsa
Technical p. 222



Mani
Technical p. 223

FURNITURE OVERVIEW

SOFAS



Tondo
Technical p. 176



Tondo
Technical p. 176



Tondo
Technical p. 177



Noa
Technical p. 184



Noa
Technical p. 184



Noa
Technical p. 186



Nero
Technical p. 189



Nero
Technical p. 189



Scoop
Technical p. 191



Scoop
Technical p. 191



Tugu
Technical p. 193



Tugu
Technical p. 193



Tugu
Technical p. 193



Legna
Technical p. 199



Legna
Technical p. 199



Mauroo
Technical p. 207

FURNITURE OVERVIEW



Mauroo
Technical p. 208



Mauroo
Technical p. 208



Flexx
Technical p. 215



Flexx
Technical p. 215

SUNLOUNGERS



Noa
Technical p. 186



Noa
Technical p. 187



Nero
Technical p. 190



Scoop
Technical p. 192



Tugu
Technical p. 195



Legna
Technical p. 200



Tecca
Technical p. 206



Mauroo
Technical p. 209



Flexx
Technical p. 217



Bistro Mantra
Technical p. 220



Bolsa
Technical p. 222

FURNITURE OVERVIEW

DAYBEDS



Tondo
Technical p. 178



Tugu
Technical p. 195



Flexx
Technical p. 217

LOW TABLES



Tondo
Technical p. 178



Tondo
Technical p. 178



Como
Technical p. 180



Como
Technical p. 181



Como
Technical p. 181



Como
Technical p. 181



Noa
Technical p. 185



Noa
Technical p. 185



Noa
Technical p. 185



Nero
Technical p. 190



Nero
Technical p. 190



Tugu
Technical p. 194

FURNITURE OVERVIEW



Tugu
Technical p. 194



Tugu
Technical p. 194



Legna
Technical p. 200



Legna
Technical p. 200



Mauroo
Technical p. 210



Mauroo
Technical p. 210



Flexx
Technical p. 216



Flexx
Technical p. 216



Flexx
Technical p. 216



Nesting tables
Technical p. 226



Nesting tables
Technical p. 226



Taro
Technical p. 228



Taro
Technical p. 228



Taro
Technical p. 229



Taro
Technical p. 229



Duncan
Technical p. 229

MAINTENANCE & PROTECTION

PROTECTION COVER

	UPJCP.1S-X77	JCP.1 Series
	UPJCP.202-X77	JCP. 202
	UPJCP.2S-X77	JCP.201 & JCP.203
	UPJCP.3S-X77	JCP.3 Series
	UPJCP.4S-X77	JCP.4 Series
	UPJCP.5S-X77	JCP.5 Series
	UPJCP.6S-X77	JCP.6 Series
	UPAZO-M-X75	Azore
	UPANT-M-X75	Antego
	UPKIN-L-X75	Lima
	UPUMB-S-X75	Tuli & Malibu
	UPAMA-M-X75	Amalfi
	UPCUB-M	Cuba & Moorea
	FP... X75	Furniture collection

To enhance the durability and appearance, we recommend following our care instructions regularly.

The umbrella should never be used in strong wind or rainy conditions. An open umbrella should never be left unattended. We always suggest storing your furniture and outdoor umbrella in a dry place when not in use or using a protective cover to avoid any blurring or damage.

FABRICS







	SPCARE-TEXT-75CL fabrics	2 sponges, 3 application cloths 1 textile protector 750ml 1 textile cleaner 750ml
---	------------------------------------	---

STONE























	SPCARE-STONE-50CL natural stone	1 sponge, 1 applicaton cloth 1 natural stone protector 500ml 1 natural stone cleaner 500ml
---	---	--

MAINTENANCE & PROTECTION

TEAK

	<p>FUCARECL-W62-1L FUCAREPR-W62-1L natural teak care kit</p> <p>Suitable for Noa, Nature, Tecca and Flexx collection & Dune dining chair</p> 	<p>teak cleaner 1000ml teak protector 1000ml</p>
	<p>FUCARE-W64-75CL sable teak care kit</p> <p>Suitable for Legna collection</p> 	<p>exterior oil 750ml exterior cleaner 250ml scouring sponge gloves & brush cloth red polishing pad & holder</p>
	<p>FUCARE-W68-75CL black teak care kit</p> <p>Suitable for Nero collection</p> 	<p>exterior oil 750ml exterior cleaner 250ml scouring sponge gloves & brush cloth red polishing pad & holder</p>

CORRECTOR PEN 12 ML

	<p>SPCOR-12ML</p>	<table border="1"> <tr> <td></td> <td>A01 white</td> </tr> <tr> <td></td> <td>A03 linen</td> </tr> <tr> <td></td> <td>A11 taupe</td> </tr> <tr> <td></td> <td>A14 lava</td> </tr> <tr> <td></td> <td>A30 anthracite</td> </tr> <tr> <td></td> <td>A31 charcoal</td> </tr> <tr> <td></td> <td>A32 black</td> </tr> </table>		A01 white		A03 linen		A11 taupe		A14 lava		A30 anthracite		A31 charcoal		A32 black
	A01 white															
	A03 linen															
	A11 taupe															
	A14 lava															
	A30 anthracite															
	A31 charcoal															
	A32 black															

Quick-drying liquid paint with built-in brush for powder-coated surfaces. Ideal for retouching small surface traces (scratches, wear).

UMBRELLA ACCESSORIES



LUNA LED LIGHT

UALUN-LED02

You create a warm glow by adding this outdoor umbrella light to the built-in holder on the frame. Luna LED light is wireless with 16 LEDs and gives a warm colour. Using the BT speaker, the module will play music for six to ten hours.

Colour: grey

Light: LED warm light

Fits on: Azore - Antego - Lima - Amalfi - Malibu



GUTTERS

Gutters offer an uninterrupted protection between several umbrellas. By connecting the parasols, large areas have a complete coverage against the sun or rainy weather. A gutter is always attached to the parasol with a slight slope in order to drain the water efficiently in the desired directions.

Our gutters are available in the same colour as the cloth of the parasol to match perfectly. Only applicable on the following parasols: JCP.201, JCP.202 and JCP.501.

MATERIALS

CARACTÈRE COLLECTION

ALUMINIUM frame

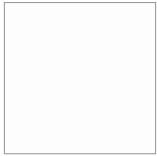

A01 white



A02 silver*

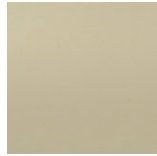

A03 linen



A10 cappuccino

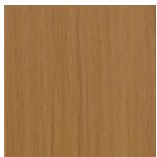

A12 alu teak



A31 charcoal



A32 black

Powdercoated aluminium.
*A02 silver = anodized aluminium

FABRICS canopy



C003 pearl



C011 cotton



C100 ice

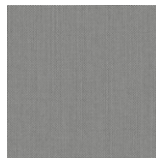

C107 mooncrest



C207 onyx

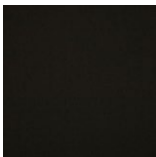

C210 pitch



C305 umber

100% solution dyed acrylic from Sunbrella® PLUS Marine collection, 320 g/m². Resin based anti-fungi coating, water and UV resistant.

STEEL Caractère collection umbrella base



S01 white



S02 silver



S03 linen



S31 charcoal



S32 black

Hot galvanised powder coated steel plates, heavy and rust free.

MATERIALS

ATTITUDE COLLECTION

ALUMINIUM frame

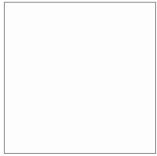

A01 white

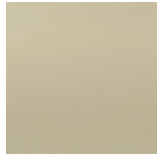

A03 linen



A12 alu teak



A14 lava



A30 anthracite



A32 black

Powdercoated aluminium.

FABRICS canopy



C001 natural



C002 white

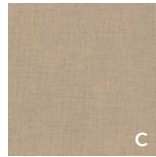

C010 latte



C101 cloud

Classic (C):
100% solution dyed acrylic, 270 g/m².
Water and UV resistant.

Basic (B):
Olefin, 240 g/m². Water and UV resistant.
* C109 speckle: 195 g/m²

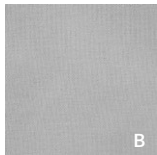

C105 light grey



C106 gris nature

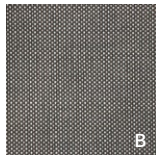

C109 speckle*

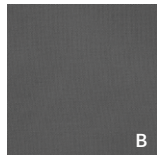

C200 dark grey



C204 night



C208 black

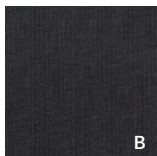

C209 coal



C211 steel



C212 gasoline

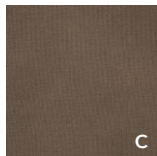

C301 taupe

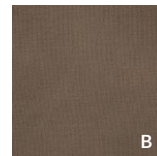

C302 mocca



C304 walnut

MATERIALS

WOOD frame



W60 eucalyptus



W63 teak scratched

W60:
tropical hardwood with smooth finish

W63:
scratched teak

NATURAL STONE umbrella base



G04 light grey granite

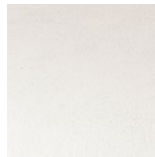

G13 Egyptian sandstone



G32 black granite

Extremely strong and low porous. Stain repellent, UV-resistant, and resistant to heat, frost and mold. Due to its natural composition, variations in colour and pattern are inherent to each stone.

STEEL umbrella base

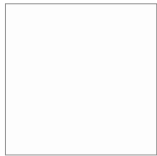

S01 white

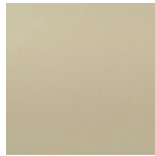

S03 linen



S31 charcoal

Hot galvanised powder coated steel plates, heavy and rust free.

CONCRETE umbrella base

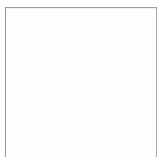

B01 white

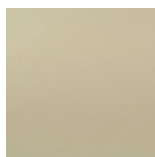

B03 linen



B06 hazel

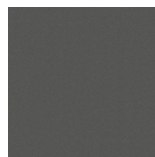

B30 anthracite



B32 black

Hot galvanised powder coated steel plates, heavy and rust free.

MATERIALS

FURNITURE COLLECTION

FABRICS frame



C005 marble
cat. D



C006 vanilla
cat. C



C007 beige
cat. C



C008 linen
cat. B

Technical details about our fabrics can be found on www.jardinico.com.

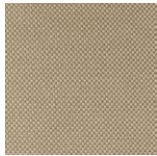

C012 cream
cat. C



C015 brûlé
cat. D



C016 pampas
cat. C



C111 truffe
cat. D

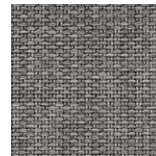

C201 charcoal
cat. C

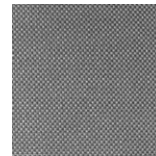

C202 smoke grey
cat. C



C205 ebony
cat. C



C206 ash
cat. A



C306 toast
cat. C



C401 corn
cat. C

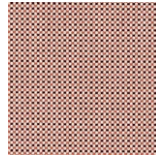

C404 diamond
cat. D

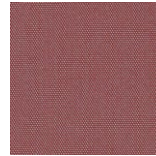

C411 ruby
cat. A



C419 lime
cat. D

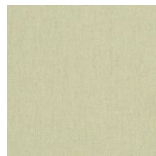

C420 mint
cat. B

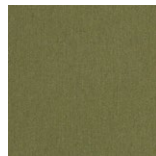

C422 sage
cat. B



C426 kaki
cat. C



C428 azul
cat. D



C429 papaya
cat. C

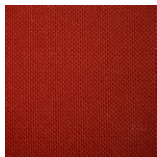

C430 cotta
cat. E



C432 petrol
cat. C



C434 turtle
cat. C

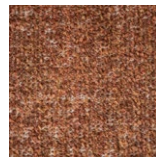

C436 amaretto
cat. C



C438 matcha
cat. D



C439 ray
cat. D



C440 scarlett
cat. B



C441 wave
cat. D



C442 peacock
cat. D

MATERIALS

TEXTILENE frame



T02 silver



T30 anthracite

Sunbrella® sling.
Stain and water repellent with a padded finish.

ROPE frame



R02 silver



R03 linen



R04 almond



R05 seal

UV-resistant polyolefin, woven by hand.



R11 artichoke

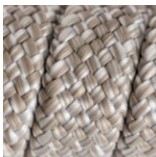

R12 cream

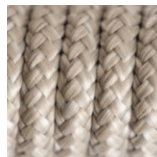

R13 sand

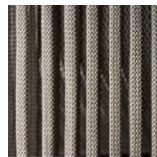

R14 brown

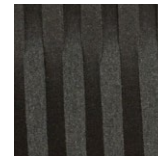

R30 anthracite

ALUMINIUM frame

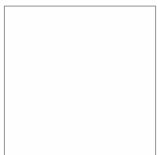

A01 white



A03 linen

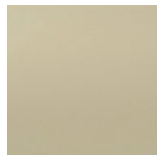

A04 almond



A14 lava

Powdercoated aluminium.

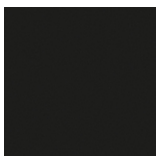

A30 anthracite



A31 charcoal



A32 black



A69 lime

MATERIALS

CERAMIC frame



K02 bianco



K14 taupegrey

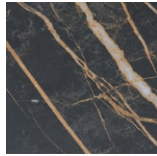

K31 charcoal

Made of natural clays and mineral colours which are pressed and fired to make a high-performing surface. Thickness of 12 mm, 0,5".

MINERAL STONE frame



X01 mist

A mixture of chalk and concrete applied by hand and spatula. Silky texture, water-repellent & waterproof.

WICKER frame



F16 cottage

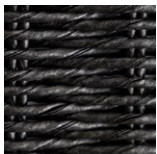

R32 black

Made of natural clays and mineral colours which are pressed and fired to make a high-performing surface. Thickness of 12 mm, 0,5".

WOOD frame

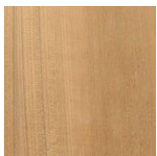

W62 teak

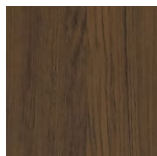

W64 sable teak

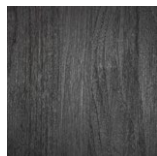

W68 black teak

W62:
Teak with matt finish.

W64 & W68:
Teak with brushed finish and coloured coating.

Jardinico Parasols BV
Evolis 101
8530 Harelbeke
Belgium
+32 (0)56 89 04 10

info@jardinico.com
www.jardinico.com



jardinico[®]

